

HEALTHSKY

EMarker-21A-C600

Multi Hopper Ultraviolet Laser Cassette Printer

User's Manual



Hangzhou HealthSky Biotechnology Co., Ltd.

CE

Version: A

Preface

■ Copyright

Hangzhou HealthSky Biotechnology Co., Ltd. (hereinafter referred to as “HealthSky”) owns the copyright of this Manual and the related software. Written permission from HealthSky is required before copying, reproducing, translating, or converting all or part of this Manual or the related software into electronic format or other device-readable formats.

■ Service Life

The service life of the device is at least five years from the date of completion of production. Please refer to the production date on the device label for the specific date.

■ Disposal

- The disposal of the device should be handled by collection facilities with qualifications for medical waste treatment.
- Infectious, pathological, and chemical waste may be present on the surface of the device.
- Complete disinfection can be achieved through methods such as microwaving, high temperature, and chemicals without secondary pollution, or incineration can be carried out. Materials that can be recycled, such as metal and glass, can be reused after complete disinfection.

■ Warranty

1. Warranty Period

The warranty period is 12 months from the date of completion of installation.

2. Warranty Coverage

- 2.1 If the user uses this device for the specified purpose and operates it according to the requirements of this Manual, HealthSky is responsible for free repair, and replacement of parts or products for users within the warranty period when the device cannot be operated normally due to the quality problems.
- 2.2 The consumable parts of this device (such as filters) are not included in the warranty coverage.
- 2.3 Maintenance out of the warranty period are chargeable service. Corresponding fees are charged based on the parts that need to be replaced, labor costs, and travel expenses.

3. Disclaimer

- 3.1 The interface may vary with the versions of the software. The figures provided in this Manual are for illustration, please refer to the actual interface.
- 3.2 Users must receive adequate training before operating the device and be fully aware of the potential dangers or hazardous steps.
- 3.3 Only trained and authorized personnel and only under the provisions of this Manual are allowed to remove any protective covers or parts of the device.
- 3.4 Maintenance must be performed only by qualified maintenance personnel authorized by HealthSky.
- 3.5 HealthSky will not be liable for any of the following:
 - 1) Failures caused by usage outside the conditions specified in this Manual.
 - 2) Failures caused by usage outside the service life of the device specified in this Manual.

- 3) Failures caused by the user's non-compliance with the operation requirements specified in this Manual.
- 4) Failures caused by improper operation and mis-operation of the user.
- 5) After installation and commissioning, failures caused by movement, transportation, or installation in ways other than those specified in this Manual.
- 6) Failures caused by disassembly, re-debugging (except load calibration), or modification of device components without authorization.
- 7) Failures caused by fire, earthquake, wind damage, flood, lightning strike, crime, terrorist activities, war, or other irresistible forces.
- 8) Failures caused by maintenance of the device by personnel not authorized by HealthSky, or failures caused by not maintaining the device by the instructions provided in this Manual.
- 9) Failures caused by not replacing consumable parts with a specified usage period on time
- 10) Failure caused by using hardware, software, consumables, or accessories not specified by HealthSky.
- 11) Failures occurring in devices that have been scrapped or in second-hand devices.

■ EMC Declaration

- The Device complies with the Emission and Immunity requirements specified in EN IEC 61326-1, EN IEC 61326-2-6.
- The Device is designed and tested according to EN IEC 61326-1, CISPR 11 Group 1, Class A equipment. In home environment, the Device may cause radio interference.
- User has the responsibility to ensure EMC environment so that the Device can function properly.
- Do not use the Device near a strong radiation source, such as an unshielded RF source, as this may interfere with the proper function of the Device.
- It is suggested to evaluate the electromagnetic environment before use of this Device.

**Chart 1 Disturbance voltage limits for class A group 1 equipment
measured on a test site (a.c. mains power port)**

Test Item	EMC Standard	Type	Limit		
			Frequency Range (MHz)	Quasi-peak value dB (μ V)	Average value dB (μ V)
Disturbance Voltage	CISPR 11	Group 1 Class A	Rated power ≤ 20 kVA		
			0.15~0.50	79	66
			0.50~30	73	60

**Chart 2 Electromagnetic radiation disturbance limits for class A group1 equipment
measured on a test site**

Electromagnetic radiation disturbance	EMC Standard	Type	Frequency Range (MHz)	3 m measuring distance	
				Quasi-peak dB (μ V/m)	Rated power ≤ 20 kVA
	CISPR 11	Group 1 Class A	30~230	50	
			230~1000	57	

**Chart 3 Immunity test requirements for equipment intended
to be used in PROFESSIONAL HEALTHCARE FACILITY ENVIRONMENT**

Port	Phenomenon	Basic Standard	Test Value	Performance Criterion
Enclosure	Electrostatic Discharge	IEC 61000-4-2	± 4 kV contact	B
			± 2 kV, ± 4 kV, ±8 kV air	B
	Electromagnetic field	IEC 61000-4-3	3V/m (80 MHz to 6 GHz)	A
	Power frequency magnetic field	IEC 61000-4-8	3A/m, (50 Hz, 60 Hz)	A
AC power (including protective earth)	Burst	IEC 61000-4-4	± 1 kV (5 kHz or 100 kHz)	B
	Surge	IEC 61000-4-5	± 0.5 kV line-to-line	B
			±1 kV line-to-ground	B
	Conducted RF	IEC 61000-4-6	3 V (150 kHz to 80 MHz)	A
	Voltage dip	IEC 61000-4-11	0% during 0.5 cycles	B
0% during 1 cycle 70% during 25/30 cycles ^a			B C	
Short interruptions	IEC 61000-4-11	0% during 250/300 cycles ^a	C	
DC power (including protective earth)	Burst	IEC61000-4-4	± 1 kV (5 kHz or 100 kHz)	N/A
	Surge	IEC61000-4-5	± 0.5 kV line-to-line	N/A
			±1 kV line-to-ground	N/A
Conducted RF	IEC61000-4-6	3 V (150 kHz to 80 MHz)	N/A	
I/O signal/control (including functional earth)	Burst	IEC61000-4-4	± 0.5 kV (5 kHz or 100 kHz)	N/A
	Surge	IEC61000-4-5	±1 kV line-to-ground	N/A
	Conducted RF	IEC61000-4-6	3 V (150 kHz to 80 MHz)	N/A
I/O signal/control connected directly to mains supply	Burst	IEC61000-4-4	± 1 kV (5 kHz or 100 kHz)	N/A
	Surge	IEC61000-4-5	± 0.5 kV line-to-line	N/A
			±1 kV line-to-ground	N/A
Conducted RF	IEC61000-4-6	3 V (150 kHz to 80 MHz)	N/A	

^a For example, "25/30 cycles" means "25 cycles for 50 Hz test" or "30 cycles for 60 Hz test".

CONTENTS

1. Important information	7
2. Product Information	11
3. Specification.....	12
4. System Description.....	13
5. Packing List	24
6. Device Installation.....	25
7. Software Setup.....	27
8. Daily Operation	35
9. HealthSky Template Editor	37
10. EMarker-21A-C600 Print Asst.	42
11. LIS Interface.....	44
12. Trouble Shooting.....	47
13. Maintenance	50

1. Important information

Thank you for choosing the HealthSky EMarker-21A-C600 Multi Hopper Ultraviolet Laser Cassette Printer!

This Manual provides the features, principle, structure, installation, operation, troubleshooting, maintenance, and safety precautions of the device.

Please read the HealthSky EMarker-21A-C600 Multi Hopper Ultraviolet Laser Cassette Printer User's Manual completely before use.

Please contact HealthSky or HealthSky authorized distributor for any help you need.

1.1 Safety Symbols

1.1.1 The Symbols used in this manual



Warnings: which may cause personal injury.



Cautions: which may cause device damage or unsatisfactory results.



Caution: Possible laser radiation.

1.1.2 The Symbols used on the device:



Protective Ground



Power On



Power Off



Serial Number



Date of Manufacture



Use by



Manufacturer



European Authorized Representative



Consult instructions for use



Country of Manufacture



The device is fully in conformance with the Regulation (EU) 2017/746 of the European Parliament and of the Council.



In Vitro Diagnostic Device



The symbol indicates that the product should not be discarded as unsorted waste but must be sent to separate collection facilities for recovery and recycling.



Caution: Possible laser radiation.



Class 4 laser product.



Avoid eye exposure to direct or scattered radiation.



Avoid skin exposure to direct or scattered radiation.

1.2 Safety Precautions

To ensure the safe operation of the device, the following instructions and warnings must be followed:

Intended Use



- The EMarker-21A-C600 is designed for use in pathology, histology, cytology, and similar laboratories, and can only be used for printing tissue cassettes.
- Do not use the product for other purposes.

Users



- For use by Trained Laboratory Personnel.
- Training by HealthSky or HealthSky authorized distributor is required before operating the device.

Environment



- The device shall be installed and operated under environmental conditions that meet the standard operating requirements specified in this Manual. Installing and operating the system in the other environment may cause device damage.
- Keep away from water sources, high-power electrical device, and strong magnetic interference fields.
- It is the responsibility of the user to ensure the electromagnetic compatibility environment for the device.

Installation and Relocation



- Only transport the device upright. Tilted transportation may cause device damage or even personnel injury.
- The device should be placed on a stable and level workbench to avoid shaking when it is running.



- Do not stack the device during relocation or storage.
- Please refer to **Chapter 6 Device Installation** before installation or relocation.



- The device may be shaken, tilted or lifted during transportation, the cassette hoppers must be removed and secured prior to each transport, otherwise, the device may be damaged.

Cassette



- Only use the compatible cassette specified in this manual. Incompatible cassettes may cause poor printing or device damage.

Before Operating the Device



- Read the EMarker-21A-C600 Multi Hopper Ultraviolet Laser Cassette Printer User's Manual completely before use.
- Please keep this Manual properly and ensure that it is accessible at any time when needed.

Operating the device



- Do not touch the moving parts of the device with your hands or other body parts during the operation to avoid physical injury.
- Power off the device before removing the protective cover. Do not operate the device or observe the inside of the device while the protective cover is removed. Any of the above actions may cause personal injury.



- Good laboratory practices should be followed.
- Operate the device strictly as instructed by this Manual. Inappropriate operation may lead to poor printing or even device damage.
- Load the cassettes strictly as instructed by this Manual. Make sure the cassettes are loaded in the right direction.
- Discard the cassettes that are printed incorrectly in time to avoid subsequent problems caused by misuse.
- Make sure that all printed information on cassettes is thoroughly verified to avoid any labeling errors.
- When the device is running, the carousel will be in a state of autorotation and lock-out. It is strictly forbidden to forcibly rotate the carousel, which will cause serious failures.
- Make sure no obstruction blocking the cassette outlet to the collection slot. Blocking will cause serious failures.
- If the device loses power suddenly, please keep it in its current state with no manual adjustment. The device will automatically reset when the power is restored. Improper operation during the power failure may cause a reset failure.

After Operation



- Please turn off the power after use. It is recommended not to leave the device on standby for a long period.

Cleaning



- Turn off the power before cleaning the device.
- Clean the device strictly as instructed by this Manual. Inappropriate operation may lead to poor printing or even device damage.
- Do not get water or other liquids into the device. Use a dry or a damp cloth that does not drip when cleaning.

Maintenance



- Maintenance should be carried out in strict accordance with the provisions in **Chapter 13 Maintenance**.
- Only qualified maintenance personnel authorized by HealthSky are allowed for maintenance and repair.

2. Product Information

2.1 Introduction

The EMarker-21A-C600 Multi Hopper Ultraviolet Laser Cassette Printer is a printing device developed by Hangzhou Healthsky Biotechnology Co., Ltd. that can leave permanent marks on the writing surface of the tissue cassettes.

EMarker-21A-C600 utilizes ultraviolet laser printing technology to create crisp, permanent, and high-resolution markings at high speed.

It is a six-hopper cassette printer with a large capacity and supports hopper selection printing to meet the cross-selection of different tissue cassette types.

EMarker-21A-C600 supports the printing of alphanumeric, symbols, graphics, linear and two-dimension barcode encoding and printing.

Supported by the user-friendly *HealthSky Template Editor* and *EMarker-21A-C600 PrintAsst.* EMarker-21A-C600 delivers efficient and quality on-demand and batch printing and enables workflow optimization.

2.2 HealthSky Template Editor

HealthSky Template Editor is used to design templates using texts, serial numbers, icons, and barcodes. It allows users to create the design from the start or by editing the template by freely adding, deleting or moving the text, serial number, icon and other available elements as well as changing their properties like font, font size, rotation and more.

2.3 EMarker-21A-C600 PrintAsst.

EMarker-21A-C600 PrintAsst. manages the running of the printer, as well as operation and data processing. It is used to select templates, edit the printing data, sequence, and perform daily print tasks.

3. Specification

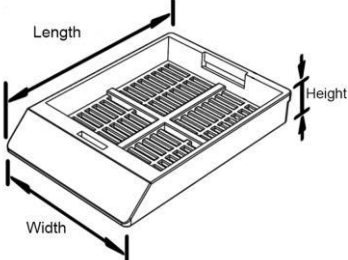
Model	EMarker-21A-C600	
Compatible Cassette	45° angle marking surface, POM material, with or without lid. Cassette dimension: Length 41~42.2 mm, width ≤28.6 mm, height 5.9~6 mm.	
Printing Technology	Non-Contact Ultraviolet Laser	
Print Head	1	
Print Color	Black to Gray	
Print Content	Alphanumeric, 1D/2D barcodes, Graphics, Symbols	
Single Print Speed*	≤3 seconds	
Batch Print Speed*	≤300 seconds /100 pcs	
Resolution	2500 dpi	
Cassette Capacity	6 hoppers	
Loading Access	1	
Single Feeding Capacity	1 pcs/access	
Operation & Display	PC	
Operating System	Windows11, Windows10, Windows 7, x64/x86; Windows XP	
Data Interface	USB	
System Interface	LIS, LIMS, HIS, PIS, PACS	
Supported Encoding Data	Texts, Numeric, Alphabets, Basic symbol	
Auxiliary Functions	Repetitive task reminder, Running fault alarm	
Supply Voltage	100-240 VAC, 50/60 Hz	
Dimension (L × W × H)	320×420×510 (mm)	
Weight	24 kgs	

*The Print Speed may vary depending on the printing contents.

4. System Description

4.1 Hardware

4.1.1 Front View

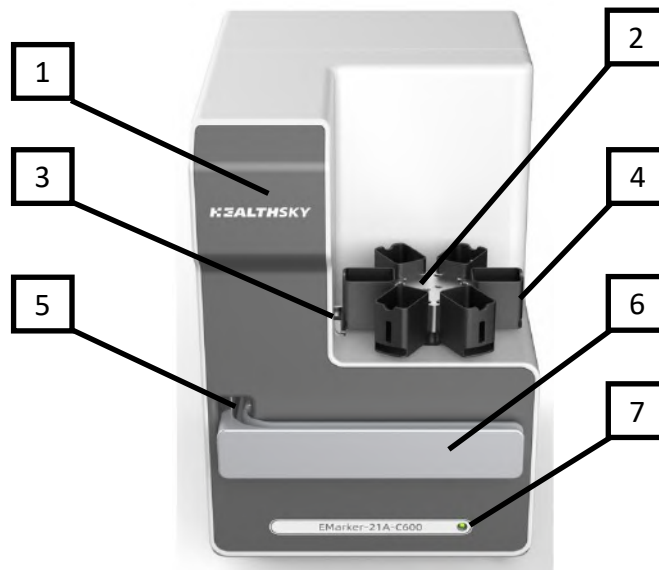

Figure 4-1 Front View

1. Mainframe: the mainframe consists of a laser device, a scanning galvanometer, and a control panel.
2. Carousel: a rotating platform with 6 location recesses for cassette hoppers.
3. Cassette Inlet: from where the cassettes are pushed into the mainframe, one cassette at a time.
4. Cassette Hopper: a container that can hold the cassette tube.
5. Cassette Outlet: from where the cassettes are pushed out of the mainframe, one cassette at a time.
6. Collection Slot: the printed cassettes are arranged neatly in the collection slot in first-in-first-out order.
7. Indicator: green indicates normal running and yellow indicates fault.

4.1.2 Back View

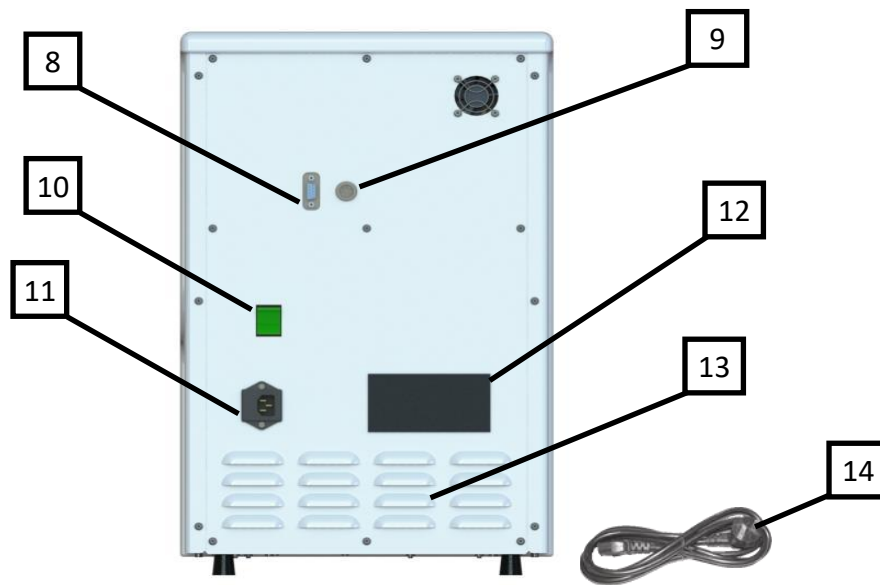

Figure 4-2 Back View

- 8. DB9 Port: used for wired connection to realize data exchange between the printer and the control terminal (PC).
- 9. Output Tray Port: used to connect the output tray (the output tray is optional).
- 10. Power Switch: for power control.
- 11. Power Port: for power entry. The power port is equipped with a fuse installation box.
- 12. Nameplate: contains basic information about the device and the manufacturer's contact information.
- 13. Ventilation Ports: used to provide adequate ventilation to maintain a proper temperature for the device.
- 14. Power Cable: connects the external power supply to the mainframe.

4.2 HealthSky Template Editor Interface

Templates determine how the data are printed.

HealthSky Template Editor is used to design templates using texts, serial numbers, icons, and barcodes. It allows users to create the design from the start or by editing the template by freely adding, deleting or moving the text, serial number, icon and other available elements as well as changing their properties like font, font size, rotation and more.

The template can also be designed to interface with laboratory information management system or accept data from scanned barcodes.

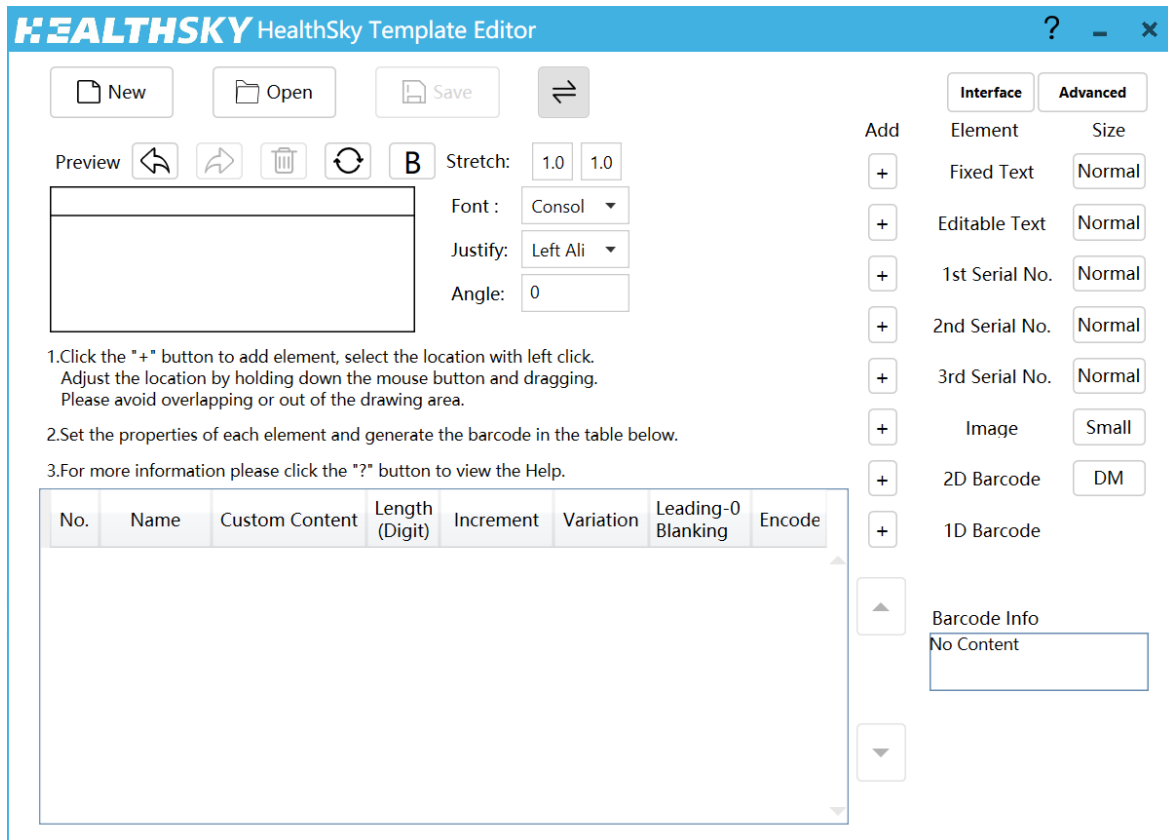

Figure 4-3 HealthSky Template Editor Interface



View Help

Click the button to enter the help page, and then click the “View Help” button to view the detail instructions on the operation of the software.



Create Template

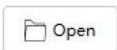

Open Template



Save Template



Switch between the Cassette Template and Slide Template

Click the button to switch between the template for cassette and slide.



Undo

Operations that add, delete, move, or modify elements can be undone.



Redo

Operations that add, delete, move, or modify elements can be redone.



Delete

Click the button to delete the selected element.



Switch the Template Direction

The printing direction of the template is settable. Click the button to switch the printing direction. The printing direction of the cassette can rotate at 0° and 180°, and the printing direction of the microscope slide can rotate at 0°, 90°, 180°, and 270°.



Font Bold

Click the button to make the selected font bold. Icons and Barcodes do not support this function.



Stretch

Select the non-icon elements, and change the value in the edit box to make the elements stretched. The stretch value can be changed by hovering over the edit box and using the scroll wheel to change it.



Font

Click the dropdown to change the element font.



Justify

Click the dropdown to change the alignment of the elements. The software supports top alignment, bottom alignment, left alignment, right alignment, horizontal center alignment, and vertical center alignment of selected elements. Select elements in the table below, and press the shortcut key to align the selected elements.



Angle

The rotation angle of the element. For example, the element in the picture on the right is rotated 9 degrees.



Display Window

The place where the print content and print layout are designed and previewed. EMarker-21A-C600 not only supports printing on the writing surface but also the thin bar above the writing surface.

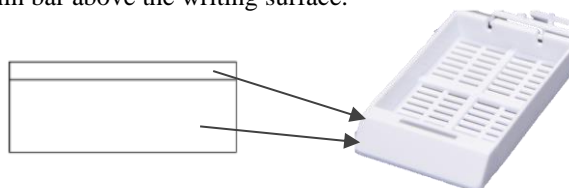

No.	Name	Custom Content	Length (Digit)	Increment	Variation	Leading-0 Blanking	Encode
1	Prefix	19-	3	0		<input type="checkbox"/>	<input type="checkbox"/>
2	Accession		5	1	Auto-incre	<input checked="" type="checkbox"/>	<input type="checkbox"/>
3	Separator	-	1	0		<input type="checkbox"/>	<input type="checkbox"/>
4	Specimen	A B C	1	0	Clear	<input type="checkbox"/>	<input type="checkbox"/>
5	Block	1 2 3 4 5 6	1	0	Invariant	<input type="checkbox"/>	<input type="checkbox"/>
6	Stain	Hr	2	0	Invariant	<input checked="" type="checkbox"/>	<input checked="" type="checkbox"/>

Element Property Setting Window

Name: to name the added element.

Custom Content: to input content for fixed text or editable text.

Length (Digit): to set the digit length limitation of the element.

Increment:

The “Increment” is only applicable for the “Serial No.”

It is the increased value of the “Serial No.”

When the value is 1, the serial no. increase by 1 after each printing.

The value ranges from 1 to 255 (and cannot exceed the upper limit of the digit length set). For example, the maximum incremental value of a one-digit serial number is 9.

Variation:

The “Variation” function can be used to set the change rules for the “Editable Text”, and the “Serial No.” after the print task is generated. “Invariant” and “Empty” options are available for “Editable Text”. “Invariant”, “Auto-increment”, and “Back to 1” are available for the “Serial No.”.

Leading-0 Blanking:

The “Leading-0 Blanking” is only applicable for the “Serial No.”.

Zeros appearing to the left of the first non-zero digit of the serial no. will be omitted or replaced with blanks after the selection box is checked.

Encode:

“Fixed Text”, “Editable Text”, and “Serial No.” are supported for barcode generation.

Click the selection box of the “Encode” column and the corresponding element will be used to generate the barcode.



Interface

Click to interface with Laboratory Information System (LIS) or other laboratory information system. Refer to **Chapter 11 LIS Interface** for operation instructions.



Advanced

Save the script file to the template through the button to realize more customized content in the *EMarker-21A-C600 Print Asst.* software. Contact the after-sales service for more detailed information.

- Fixed Text
- Editable Text
- 1st Serial No.
- 2nd Serial No.
- 3rd Serial No.
- Image
- 2D Barcode
- 1D Barcode

Add Element

Left click the “+” button in front of the element.

Select a location in the display window, left click to add the element.

Fixed Text

The “Fixed Text” can be used as fixed content, such as the year, the laboratory name, or the separator.

Editable Text

The “Editable Text” can be used for application scenarios when the printing content requires to be edited on-site, such as the date, the specimen no., the block no., the stain type etc.

Serial No.

The “Serial No.” can be used for application scenarios when a series of tasks need to be created, such as the accession no., cassette no. etc.

Image

The “Image” can be used to import images for printing.

2D Barcode

The “2D Barcode” can be used to generate a QR Code or a DataMatrix Code.

1D Barcode

The “1D Barcode” can be used to generate the Code128A.



Normal

Click the button to switch between the conventional font and the flat font.

The conventional font can be used for the content on the writing surface.

The flat font can be used for the content on the thin bar.



Small

Click the button to switch between small and large images.



QR

Click the button to switch between the QR code and the Datamatrix code.



Encoding Order Adjustment

The encoding order is adjustable by adjusting the order of the elements. Adjust the order by clicking the two buttons.



Barcode Info Preview

The encoded content could be previewed.

Refer to **Chapter 9 HealthSky Template Editor** for detail instructions on the operation.

4.3 EMarker-21A-C600 PrintAsst. Interface

4.3.1 Main Interface

EMarker-21A-C600 PrintAsst. manages running of the printer, as well as operation and data processing. It is used to select templates, edit the printing data, sequence, and perform daily print tasks.

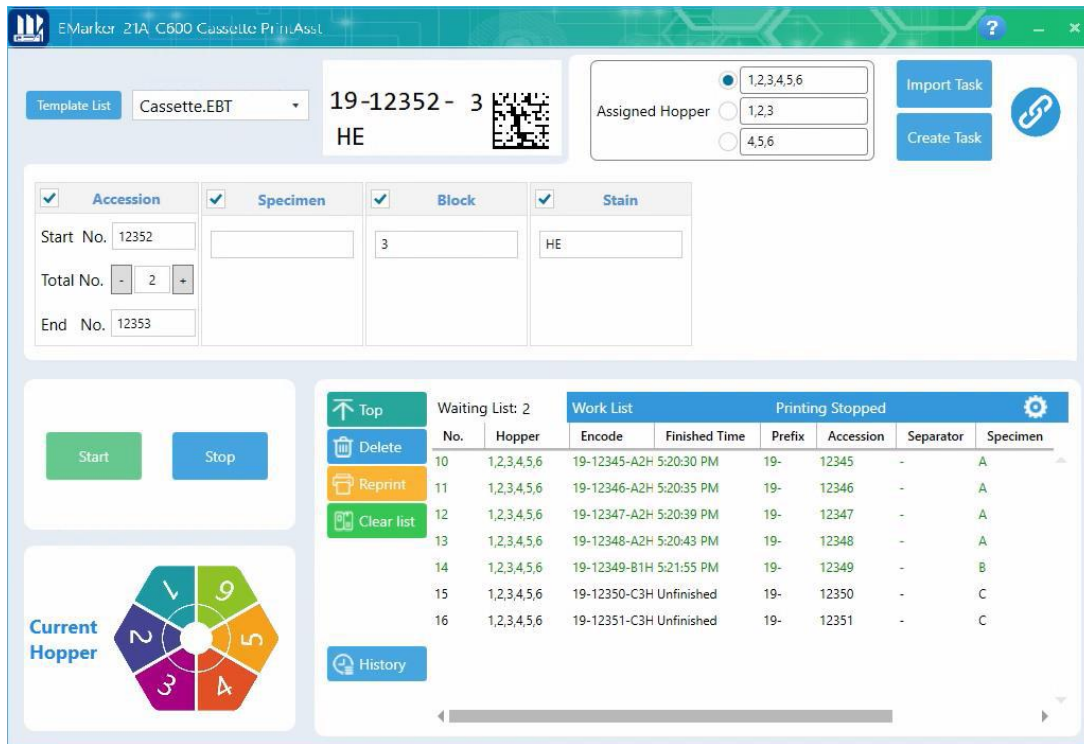

Figure 4-4 EMarker-21A-C600 PrintAsst. Interface



View Help

Click the button to enter the help page, and then click the “View Help” button to view the detailed instructions on the operation of the software.



Template List

Click the button to select a template for printing.

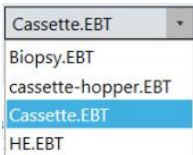

Template Name

The name of the currently opened template name. Click the drop-down arrow to view the template list.

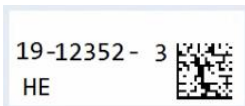

Template Preview

The preview of the opened template.

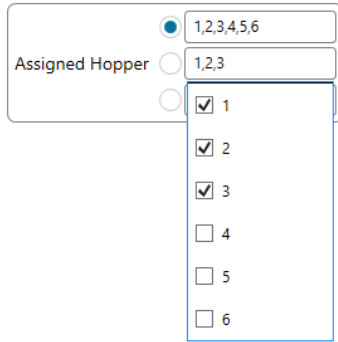

Assign Cassette Hoppers

Click the input box to assign certain hoppers for printing.



Import Task

Click the button to import the printing tasks.



Create Task

Click the button to create the printing tasks.



It indicates that the printer doesn't connect to the PC.



It indicates that the printer connects to the PC successfully.

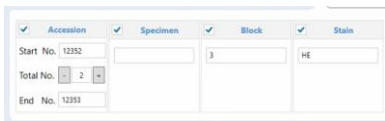

Task Editing Area

The "Editable Text" and "Serial No." in the template will be displayed here in order. Enter the content for printing. The starting number, number of prints, and end number can be set for the "Serial No.".

Check the check box in the upper left corner of each element to determine whether the element is to be printed.

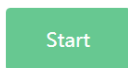

Start

Click the button to enter the printing mode.



Printing

The "Start" button converts to the "Printing" button after it is clicked. It indicates the printer is under the printing mode.



Stop

Click the button to exit the printing mode.



Current Hopper

It indicates the current printing hopper.

Click the hopper number on the wheel to quickly switch to the specified hopper.



Top

Click the button to top the selected printing tasks.



Delete

Click the button to delete the selected printing task.



Reprint

Click the button to reprint the selected printing task.



Clear list

Once click the button, the finished & unfinished printing task will be cleared.

Waiting List: 2		Work List	Printing Stopped
No.	Hopper	Encode	Finished Tim
3	1,2,3,4,5,6		1:21:19 PM
14	1,2,3,4,5,6	Unfinished	Text1
15	1,2,3,4,5,6	Unfinished	Text1

Waiting List/Work List

The completed tasks are displayed in green, the uncompleted tasks are displayed in black. The number of remaining tasks is displayed as the “Waiting List”.



History

Click the button to review the history printing task.

Start Date

End Date

Click “Start Date” & “End Date” to expand the range of history printing task records.

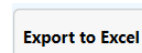

Export to Excel

Click the button to export the printing history as an Excel file.

4.3.2 Work list organizing

Click the “” button to order, and display/hide the columns of the “Work List”. The settings of the “Work List” are associated with the template. The settings are automatically loaded after the template is opened.

Waiting List: 2		Work List	Printing Stopped
No.	Hopper	Encode	Finished Time
10	1,2,3,4,5,6	19-12345-A2H	5:20:30 PM
11	1,2,3,4,5,6	19-12346-A2H	5:20:35 PM
12	1,2,3,4,5,6	19-12347-A2H	5:20:39 PM

Figure 4-5

Table columns can be moved left, right, hidden, and displayed. As shown in Figure 4-6.

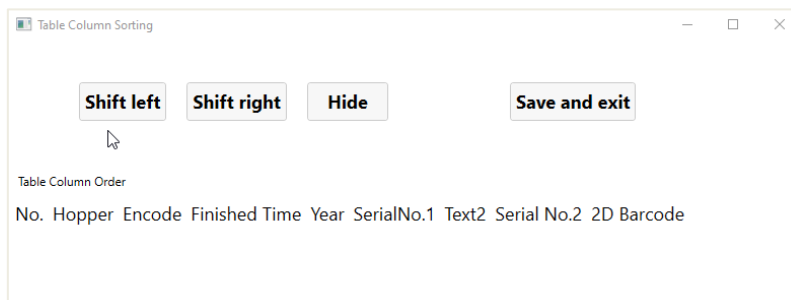

Figure 4-6

4.3.3 Printing Parameters Settings

Press the key combination “Ctrl+H+S” to open the advanced Settings. As shown in Figure 4-7.

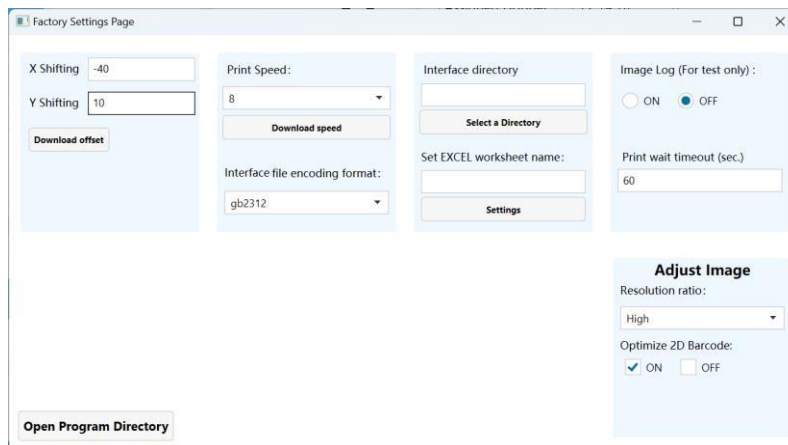

Figure 4-7

1) Printing Layout Adjustment

When the actual printing layout is different from the template layout, adjust the value of the “X Shifting” and “Y Shifting”, click the “Download offset” button, then test the printing.

2) Printing Speed

The printing speed can be set by adjusting the “Print Speed” value. The higher the value, the faster the speed and the lighter the print color. After setting the value, click the “Download speed” button to complete the setting.

3) Interface File Encoding Format

Interface file encoding format supports gb2312, utf-7, utf-8, utf-32, utf-16, us-ascii.

4) Interface Directory

When interface with laboratory information system, select the directory where the interface files are saved.

5) Set EXCEL Worksheet Name

When the interface file type is an excel file and there are multiple sheets in the file, the sheet name needs to be specified here. The default is the first worksheet.

6) Image Log (For test only)

The Image log recording switch is usually turned off. It can be turned on when after-sales personnel need to view the Image log. After turning it on, Image screenshots of each print task will be generated in the software installation directory/Image, as shown in Figure 4-8.

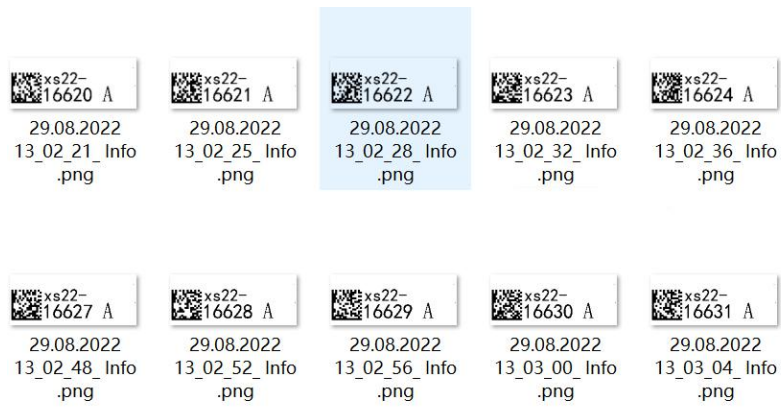

Figure 4-8

7) Print Wait Timeout (sec.)

When the printing task is not completed within the time specified in the dialog box, the printing will suspend and a reminder will pop-up.

8) Adjust Image

The default state of Resolution ratio is normal, and the default state of Optimize 2D Barcode is on. If any adjustment is needed, please contact the after-sales personnel.

5. Packing List

No.	Item	Model	Quantity(p
1	Multi Hopper Ultraviolet Laser Cassette Printer	EMarker-21A-C600	1
2	Cassette Hopper		6
3	USB to DB9 Adapter Cable		1
4	Power Cord		1
5	Fuse	TBC T2AL250V	2
6	User's Manual		1
7	QC Certificate/Inspection Report		1
8	Warranty Card		1

6. Device Installation



- Installation of the EMarker-21A-C600 can only be performed by HealthSky authorized personnel.

The user should prepare the proper site for installation. The device shall be installed by HealthSky authorized personnel only.

6.1 Site Preparation



- The device must be installed and operated under environmental conditions that meet the standard requirements specified in this manual. Installing and operating the system in other environment may cause poor printing or even device damage.

6.1.1 Power Requirements

- 1) Power supply: AC 100-240V, 50/60Hz, 300VA, three-wire power cord and properly grounded.
- 2) The system should be connected to a properly grounded power socket.
- 3) The distance between the power socket and the system should be less than 1.5 meters.

6.1.2 Environmental Conditions

- 1) Indoor Use only.
- 2) Altitude: up to 2,000 m (6,562 ft).
- 3) Temperature: between 5~40°C.
- 4) Humidity: maximum relative humidity 80% is for temperature up to 31 °C, relative humidity decreases linearly to 50% at 40 °C.
- 5) Supply voltage fluctuation: $\leq \pm 10\%$ of the nominal voltage.

6.1.3 Workbench Requirements

- 1) Horizontal workbench with sufficient rigidity.
- 2) If a movable bracket or trolley is used, a locking device should be used.
- 3) Workbench loading capacity: ≥ 24 kg.
- 4) Workbench dimension: length ≥ 520 mm, depth ≥ 520 mm.

6.1.4 Space Requirements

Leave necessary space around the device when installing it.



- Leave necessary space around the device to ensure the heat dissipation of the device.

- 1) Leave at least 100 mm of space on the left and right sides of the device.

- 2) Leave at least 100 mm of space at the back of the device. Ensure that the vents are unblocked.
- 3) Leave at least 410 mm of space above the device to ensure the cassette's loading.
- 4) Leave space for the PC which is used to control the device.

6.2 Unpack the Device

- 1) Carefully inspect the package of the device when receiving it. Any signs of mishandling or damage, please contact HealthSky or the authorized distributor immediately.
- 2) Check the goods per the packing list after unpacking, if anything missing or damaged, please contact HealthSky or the distributor immediately.

6.3 Carrying the Device

- 1) When carrying the device, it is necessary to lift from the left and right sides of the device and balance the force.
- 2) Please carry the device vertically and do not shake it.
- 3) When transporting the device or for long-distance, please use the original package. Properly fix the device firmly keep it in a vertical state and handle it with care.



- Risk of injury while lifting and carrying heavy loads.
- Lifting and transporting of the device should be done with a sufficient number of helpers. Use a transport aid for transporting the device.

6.4 Install the Device

- 1) Connect one end of the power cable to the power port and the other end to the socket.
- 2) Use the USB to DB9 Adapter Cable to connect the printer and the computer.
- 3) Insert the cassette hoppers into the slots of the carousel.
- 4) Turn on the printer.



- If there is a large temperature difference between the warehouse and the installation site and the air humidity is high, condensation may form inside the device. In this case, wait for at least two hours before turning on the device, otherwise, the device will be damaged.

6.5 Storage and Transportation

- 1) For indoor storage.
- 2) The maximum stacking number is 2 when using the original packaging.
- 3) Storage and transportation conditions:

Temperature: -20°C to 55°C

Humidity: maximum relative humidity 80% (non-condensation)

Air pressure: 50~106 kPa

- 4) During transportation, please keep the device upright and avoid prolonged exposure to sunlight and moisture.

7. Software Setup

7.1 Hardware Requirements

	Minimum Requirements
Processor:	1.8 GHz processor
Memory:	2GB
Storage:	Solid State Drive (SSD) 300MB available space
Resolution:	1024*768 minimum display resolution
Input:	Keyboard and mouse required

7.2 System Requirements

Windows operating system (Windows XP SP3 or above) installed with .NET Framework4.0 or later. If only the service framework is missing, install it during the subsequent software installation.

If the operating system is the ghost version, install the complete set of control software in advance and confirm whether the software can run successfully.

7.3 Software Installation

7.3.1 Preparation for Installation

1) Copy the EBMarker Installer Package

For computers that support software installation with a USB flash drive, copy the EMarker-21A-C600 Installer Package to the computer for installation.

When authority or approval is required to install software, please contact the management first.

2) Unzip the EBMarker Installer Package. The following files are contained in the unzipped folder.

Name	Type	Size
Running Essentials	File folder	
EMarker-21A-C600-V1.12.00.4.exe	Application	9,801 KB
TemplateEditor-V1.0.4.exe	Application	5,639 KB

Figure 7-1

7.3.2 Running Essentials

Open the “Running Essentials” folder, as shown in Figure 7-2.

Name	Date modified	Type	Size
CDM212364_Setup.exe	2021/7/12 13:11	Application	2,212 KB
dotNetFx40_Full_x86_x64.exe	2019/5/13 10:15	Application	49,268 KB

Figure 7-2

1) Install the .NET Framework

.NET Framework 4.0 and above is required for the software installation.

The user can double-click the “dotNetFx40_Full_x86_x64.exe” file contained in the folder to install the .NET Framework.

If the computer is already installed with the .NET Framework 4.0 or a later version, after clicking the file, a reminder will be displayed. Please skip to the next step.

2) Install the Serial Driver

- Double click the “CDM212364_Setup.exe” file to install the serial driver. Click “Extract” during the installation process. As shown in Figure 7-3.



Figure 7-3 Install the serial cable driver

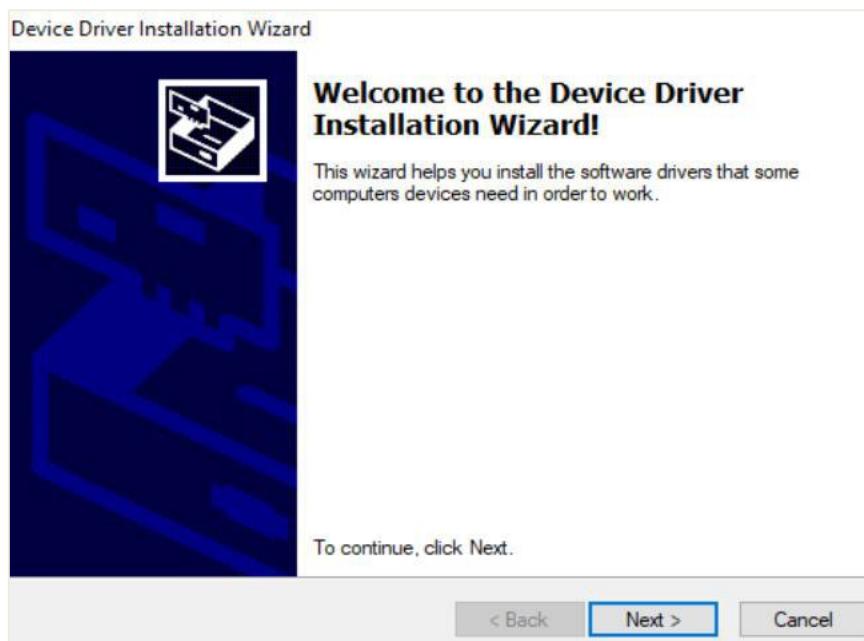

Figure 7-4

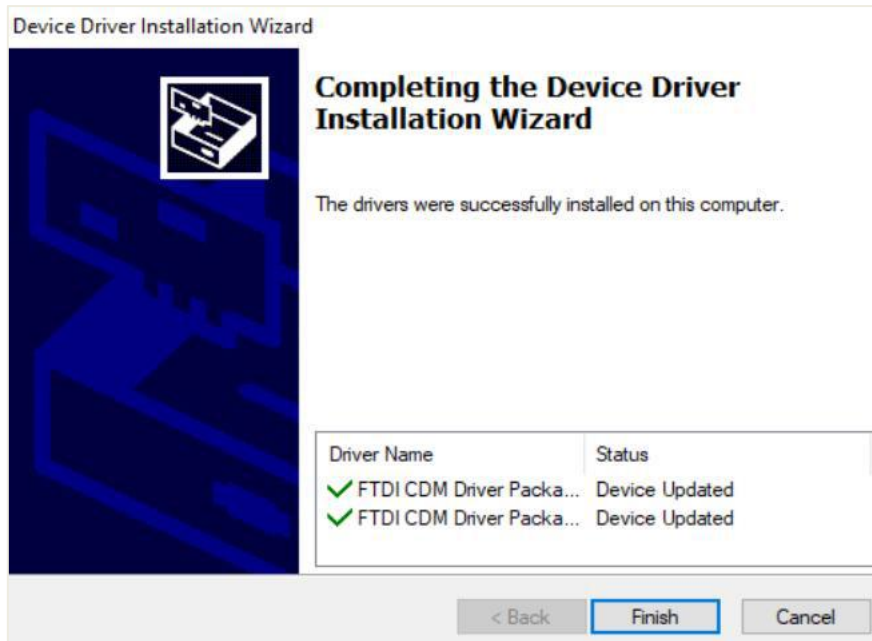
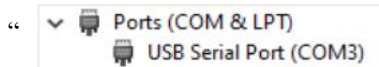

Figure 7-5

- After the serial driver is installed, check the Device Manager, when “



” turns to



”, it indicates that the serial driver is successfully installed.

7.3.3 Install the HealthSky Print Template Editor

Double-click the “TemplateEditor-V1.0.4.exe”, and follow the instructions to install the HealthSky Print Template Editor. As shown below. The icon  can be found on the desktop after installation.

Name	Type	Size
Running Essentials	File folder	
EMarker-21A-C600-V1.12.00.4.exe	Application	9,801 KB
TemplateEditor-V1.0.4.exe	Application	5,639 KB

Figure 7-6

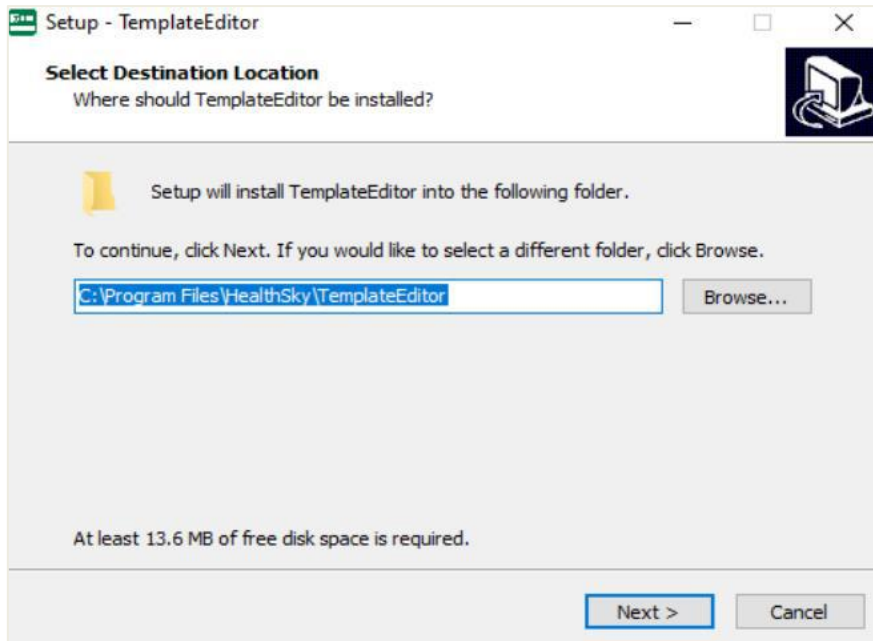

Figure 7-7

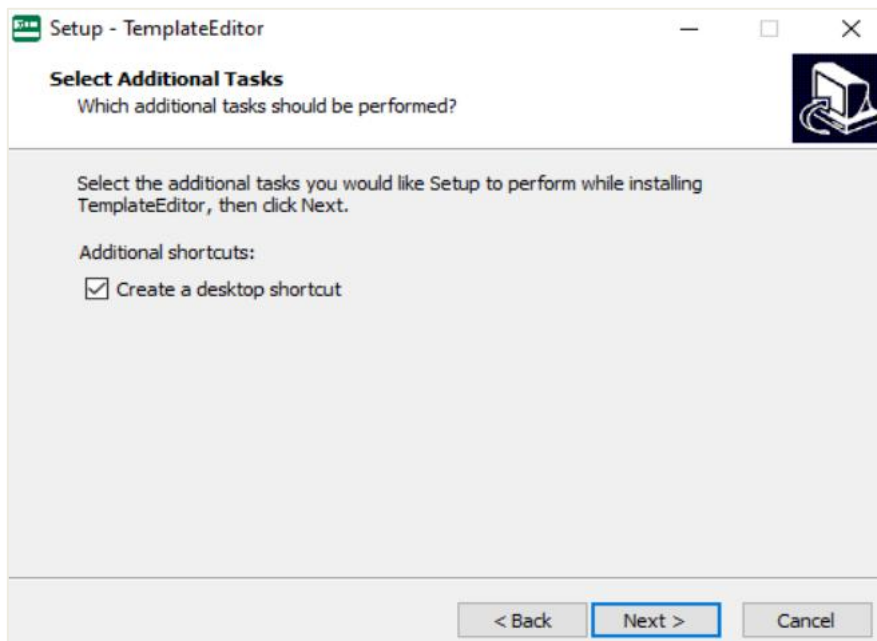

Figure 7-8

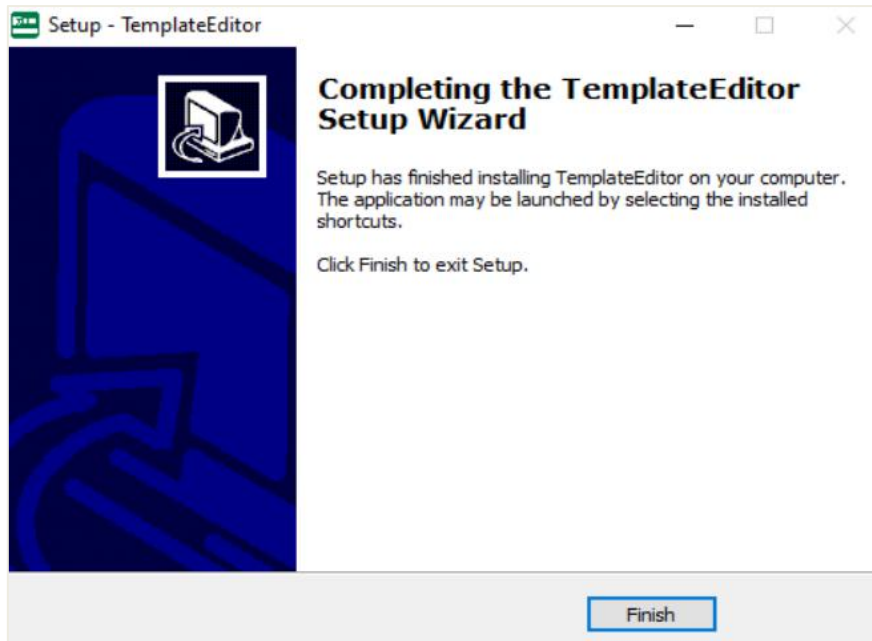



Figure 7-9

7.3.4 Install the EMarker-21A-C600 PrintAsst.

1) Install the software

Double-click the “EMarker-21A-C600-V1.12.00.4.exe”, and follow the instructions to install the EMarker-21A-C600 PrintAsst. As shown below. The icon  can be found on the desktop after installation. Administrator authority is required when the software is going to be installed in C Drive.

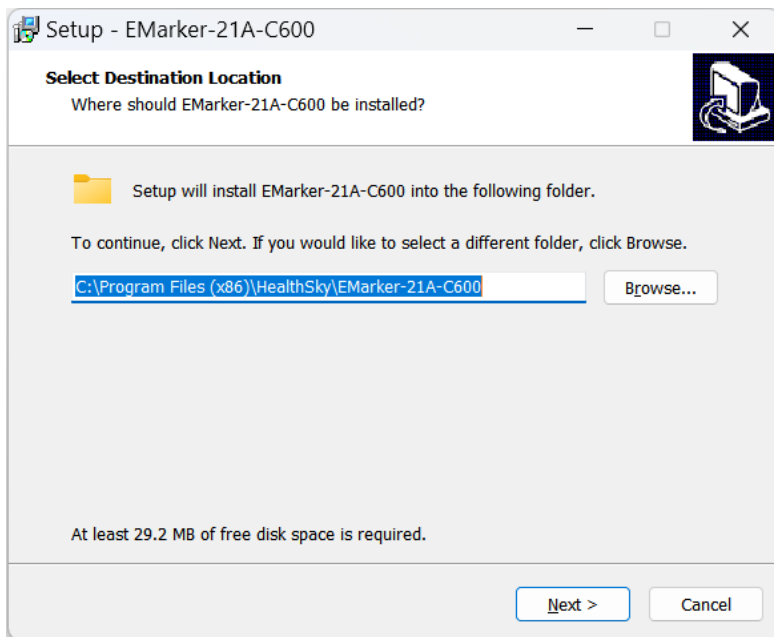

Figure 7-10

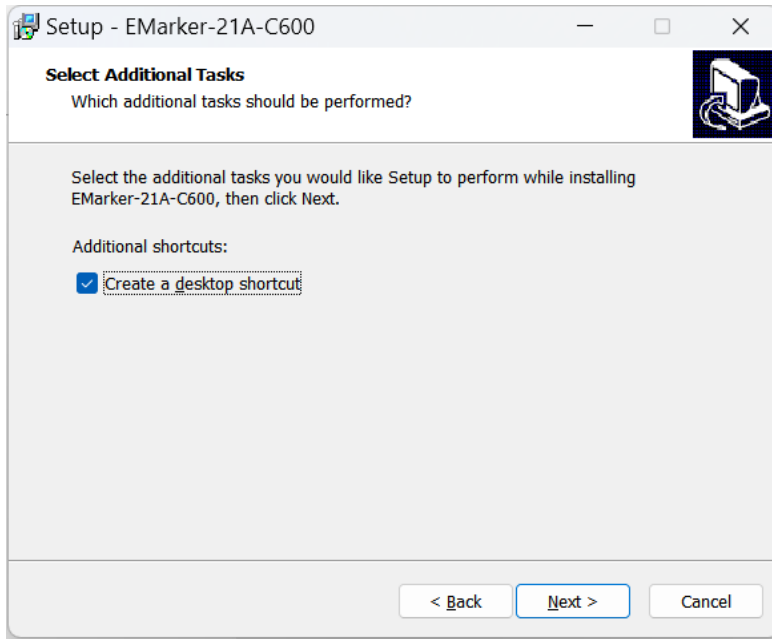

Figure 7-11

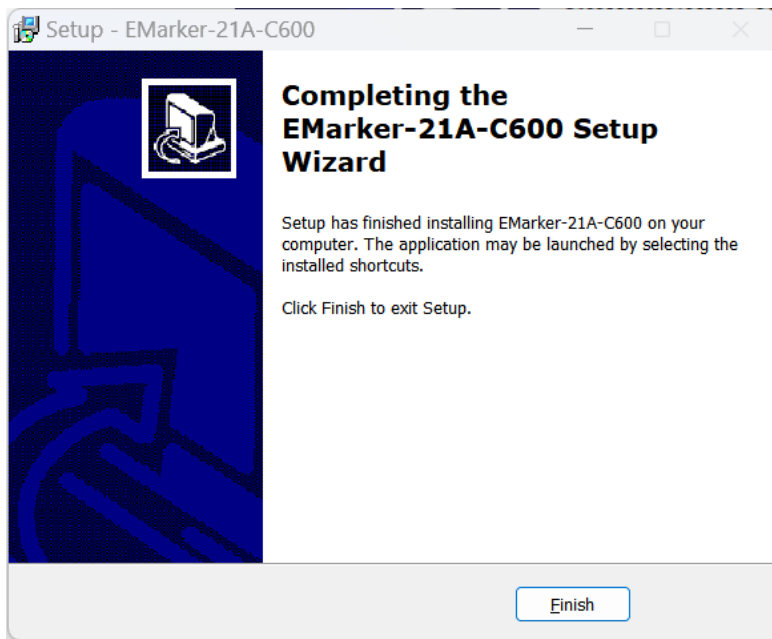

Figure 7-12

2) Run as administrator

Right-click the shortcut icon, select “Properties” in the window that pops up. Click Compatibility, check “Run this program as an administrator” option, and finally click the “OK” button. As shown below.

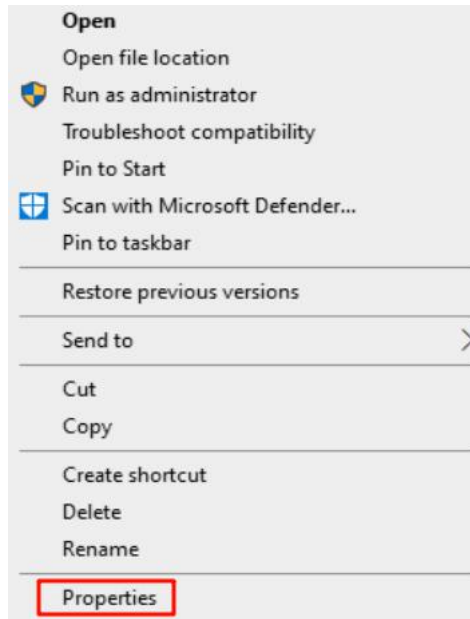

Figure 7-13

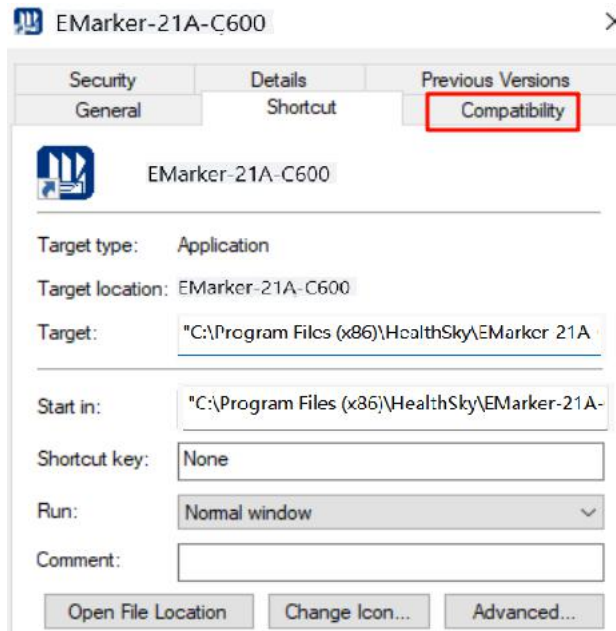

Figure 7-14

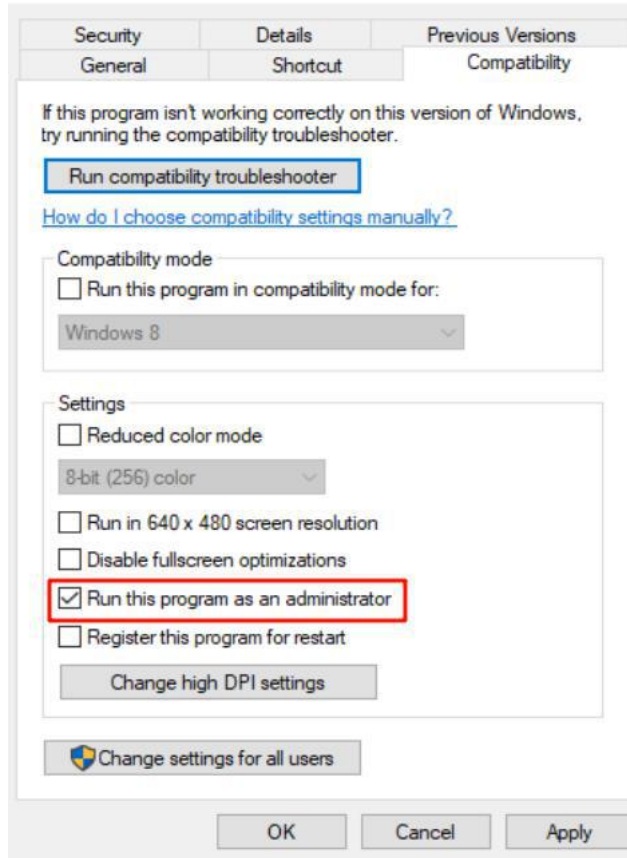

Figure 7-15

8. Daily Operation

8.1 Fill the Cassettes

Insert the cassette tube into the cassette hopper (Figure 8-1) and insert the cassette hopper into the slot of the carousel (Figure 8-2).

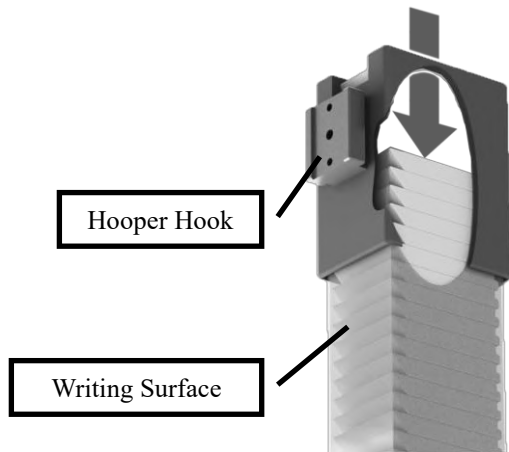

Figure 8-1

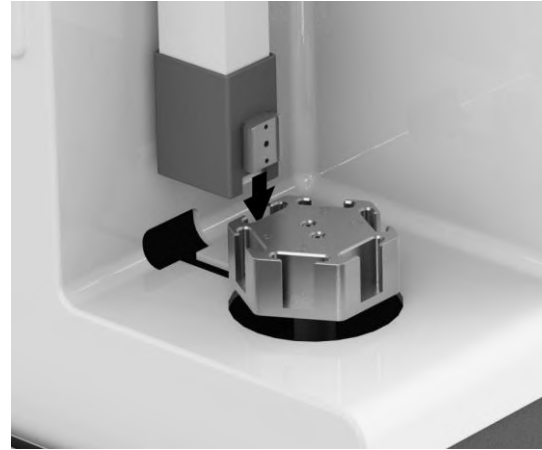

Figure 8-2

1) Open the seal at the bottom of the cassette tube and remove the end-cap. Take down the cassette hopper and turn it upside down, insert the cassette tube into the cassette hopper. **Ensure the writing surface should be oriented towards the side of the hopper hook.**

2) Put your finger against the bottom of the box as indicated by the arrow.

3) Keep your finger on the bottom of the cassette, turn over the cassette tube - cassette hopper and avoid the cassettes spilling out of the tube. Slowly withdraw your finger from the bottom.

4) Insert the cassette hopper into the slot of the carousel. Ensure the cassette hopper is completely inserted into the slot.

8.2 Turn on the Printer

Connect the power cable behind the printer, and the data cable between the computer and the printer.

Turn on the power switch at the back of the printer and wait until it is reset.

After the printer is powered on, it takes about 20 seconds to complete the initial preparation.

Please power on the printer first and then open the software.

8.3 Print



- Make sure that all printed information on cassettes is thoroughly verified to avoid any labeling errors.



- Laser is invisible light, do not open the access panel when the power is on.
- If laser burn occurs, get medical help immediately.

8.3.1 Print by EMarker-21A-C600 PrintAsst.

Please refer to **Chapter 10 EMarker-21A-C600 PrintAsst.** for detailed instructions.

8.3.2 Print Via LIS

Please refer to **Chapter 11.5 LIS Daily Print** for detailed instructions.



9. HealthSky Template Editor

9.1 Open the HealthSky Template Editor

Find the *HealthSky Template Editor*  or its shortcut, and double-click to open it.

9.2 Switch to the Cassette Template

HealthSky Print Template Editor can be used to design the slide template and cassette template.

Click the “” button to switch to the cassette template. Click the “” to the direction of the text. As shown in Figure 9-1.

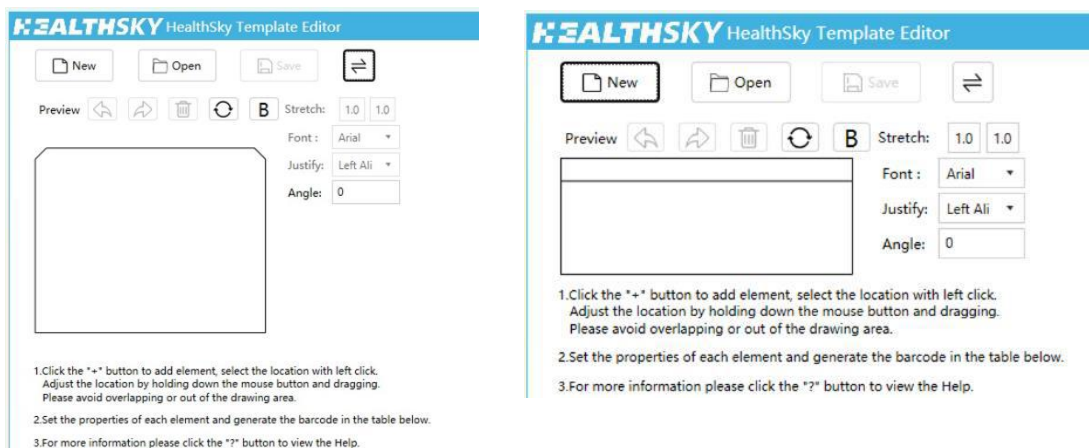

Figure 9-1

9.3 Quick Start

The general practice to create the template is to segment printing data, classify the data by fixed text, editable text, serial number, etc. based on the characteristics of the data.

The layout can be designed by changing the properties like the location, font, font size, rotation and more the location, size, and other characters of the parameters.

9.3.1 Fixed Text

The “Fixed Text” can be used as fixed content, such as the year, the laboratory name, or the separator.

The following steps illustrate how to set the year by the “Fixed Text”:

- **Add the element**

Left-click the “” button in front of the “Fixed Text” on the right.

Select a location in the display window, left click to add the element. As shown in Figure 9-2. Move the cursor to the “Fixed Text”, hold down the left mouse button and drag, the location of the “Fixed Text” can be adjusted.

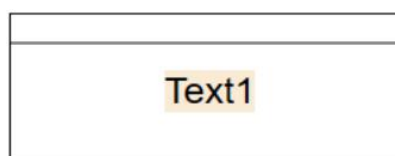

Figure 9-2

- **Name the element**

Double-click the “Name” cell of the newly added element in the table below, change the content to “Year”, and then press TAB or click another cell in order to change the name. As shown in Figure 9-3.

It is recommended to enter the name for each added element to avoid confusion and repetition. For example, if there are two hyphens (-), use “hyphen 1” and “hyphen 2” to distinguish them.

- **Input the fixed content**

Double-click the “Custom content” cell and change the content, such as “19-”.

- **Set the other properties**

Set the other properties (Increment, Variation, Leading-0 Blanking) as needed. Refer to **Chapter 4.2 HealthSky Template Editor Interface** for detail information.

No.	Name	Custom Content	Length (Digit)	Increment	Variation	Leading-0 Blanking	Encode
1	Year	19-	5	0		<input type="checkbox"/>	<input type="checkbox"/>

Figure 9-3

- **Adjust the font and font size**

Adjust the Font, Justify, and Angle as needed.

Move the cursor to the element in the display window, the current font size will be shown. As shown in Figure 9-4.

Use the mouse wheel to scroll up and down and change the font size.

Ctrl - and Ctrl + on the keyboard could be used to change the font size.

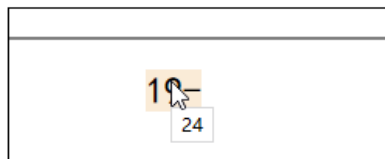

Figure 9-4

9.3.2 Serial No.

The “Serial No.” can be used for application scenarios when a series of tasks need to be created, such as the accession no., cassette no., etc. The 1st Serial No. could be used as “Accession No.”, the 2nd Serial No. could be used as “Block No.”, the 3rd serial No. could be used as “Slide No.”.

The following steps illustrate how to set the accession no. by the “Serial No.”:

- **Add the element**

Add the element and adjust the location of the element as the method described in “Fixed Text”.

- **Name the element**

Name the added element as the method described in “Fixed Text”.

- **Set the length**

Specify the digit length according to the number that the user may input. For example, if the largest accession no. is 99999, input 5.

Adjust the location, name the element, and adjust the font size as the method described in “Fixed Text”.

- Set the other properties

Set the other properties (Increment, Variation, Leading-0 Blanking) as needed.

- Adjust the font and font size

Adjust the font and font size as the method described in “Fixed Text”.

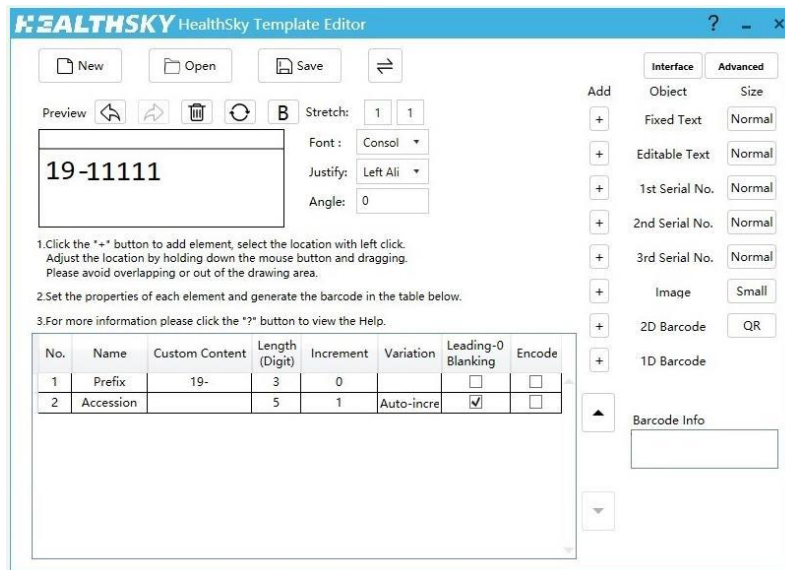

Figure 9-5

Three types are available for “Serial No.”: pure numbers, pure letters, and alphanumerics. Input letters, numbers, or alphanumerics in the “Custom Content” of the “Serial No.” to set the property. The default “Serial No.” is pure numbers.

Pure Letters Type

The Serial No. only contains letters, such as “aa”, “aB”, “AA”, and etc.

In this type, the Serial No. increases follow the alphabetical order. For example, when the increment is 2, the next of ACZ is CEB.

Pure Numbers Type

The Serial No. only contains numbers.

In this type, the numbers increase based on the decimal system. For example, when the increment is 2, the next of 100 is 102.

Alphanumerics Type

The Serial No. combines both alphabetic characters (letters) and numeric characters (numbers), such as “1a”, “A1”, and etc.

In this type, the Serial No. increases from 0 to Z (0,1,2,3...7,8,9, A, B, C...X, Y, Z.). For example, the next of 19 is 1A, the next of 1Z is 20. That is, 9 plus 1 becomes A, Z plus 1 becomes 0 and carry 1.

9.3.3 Editable Text

The “Editable Text” can be used for application scenarios when the printing content requires to be edited on-site, such as the date, the specimen no. the block no., the stain type etc.

Add the element, adjust the location, and set the properties as the method described in the “Fixed Text” and “Serial No.”.

Frequently used words can be input in the “Custom Content”. The words will be listed in the *EMarker-21A-C600 PrintAsst.* accordingly. Use separators such as “,” “;”, or blank to separate the words.

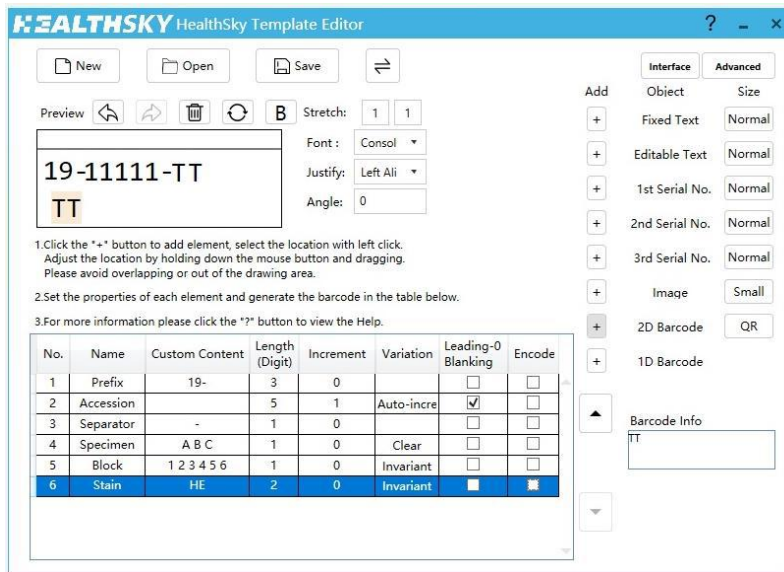

Figure 9-6

9.3.4 Barcode Generation

Both one-dimension barcode and two-dimension barcode can be generated.

Code128A is available for one-dimension barcode.

QR code and DataMatrix are available for two-dimension barcode.

Add the barcode element, adjust the location and set the properties as the method described above.

Double-click the selection box of the “Encode” column, the corresponding element will be used to generate barcode.

“Fixed Text”, “Editable Text”, and “Serial No.” are supported for barcodes generation.

The encoded content could be previewed in the window on the right. The order of the encoded content can be adjusted by clicking the up and down arrows on the right.

The encoding order is adjustable by adjusting the order of the encoding content. Adjust the order by the “▲” and “▼” buttons on the right side of the table.

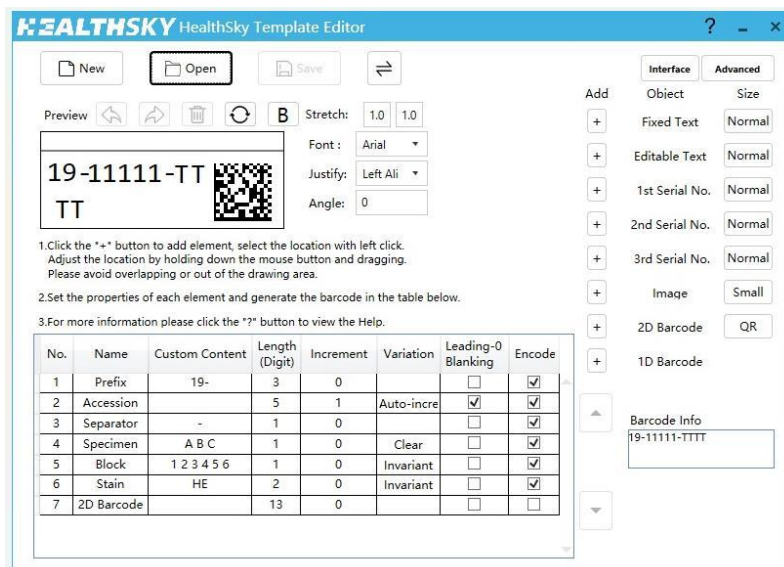



Figure 9-7

9.3.5 Save the Template

Save the template and name it properly.

Click the “  Save ” button, select a path in the pop-up window, enter the template name, and click “Save” to save the template to the specified path.

9.4 Shortcut Keys

- 1) Use the shortcut key F1 to enter the help page.
- 2) Arrow keys on the keyboard (up, down, left and right): move the selected elements.
- 3) Ctrl + Z/ Ctrl + Y: undo and redo.
- 4) Ctrl + S/Ctrl + O: save/open the template.
- 5) Ctrl + ↑ / Ctrl + ↓ : Align the selected elements to the top or bottom.
- 6) Ctrl + ←/ Ctrl + →: Align the selected elements to the left or right.
- 7) Ctrl + H/ Ctrl + J: Align the selected elements to the horizontal center or vertical center.
- 8) Ctrl + +/Ctrl + -: Resize the regular sized elements by pressing the Ctrl + + and Ctrl + - shortcuts or by directly by the mouse wheel.

10. EMarker-21A-C600 Print Asst.

10.1 Open the EMarker-21A-C600 PrintAsst.

Find the *EMarker-21A-C600 PrintAsst.* or its shortcut, and double-click to open it. Make sure to “Run as an administrator”. Refer to **Chapter 7.3.4 Install the EMarker-21A-C600 PrintAsst.**

10.2 Quick Start

10.2.1 Select the Template

Click the “ **Template List** ”, the file selection window will pop up. Select the template created previously and open it. The preview of the current template will be displayed at the top of the interface. As shown in Figure 10-1.

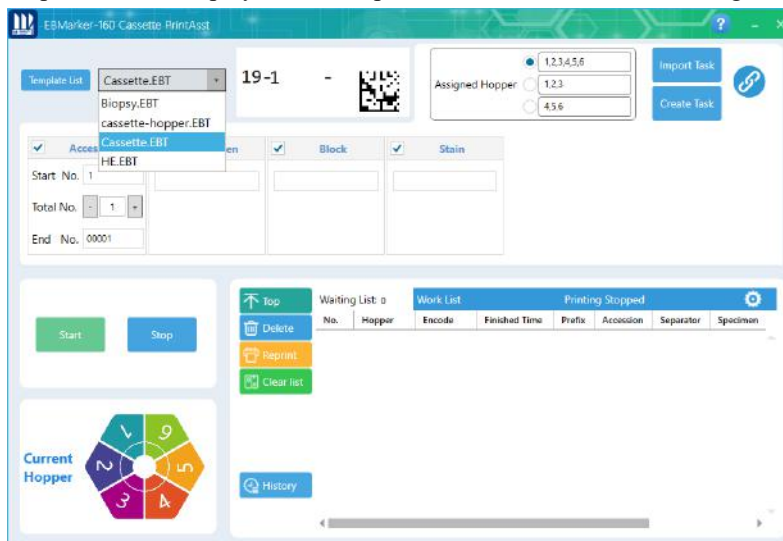

Figure 10-1

10.2.2 Assign Cassette Hopper

The software supports hopper assignments.

Check the hopper number in the “Assigned Hopper” input box to assign the cassette hopper.

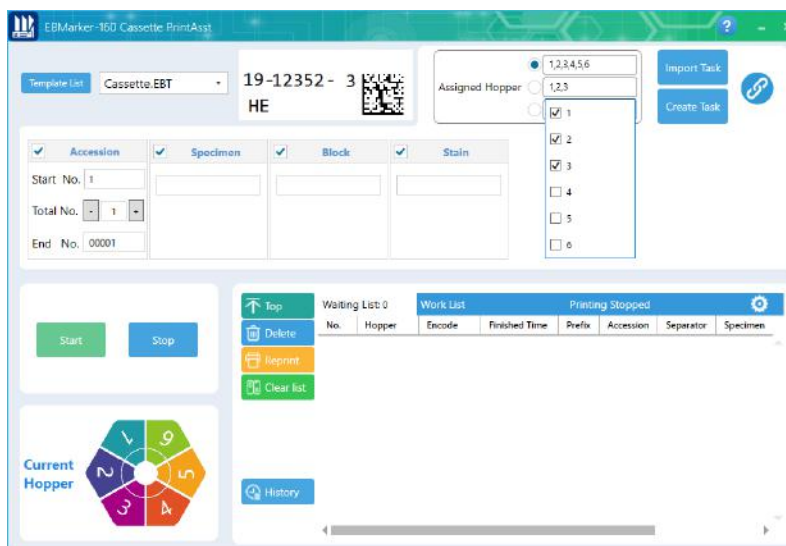

Figure 10-2

10.2.3 Input Printing Data

Input the printing data as shown below.

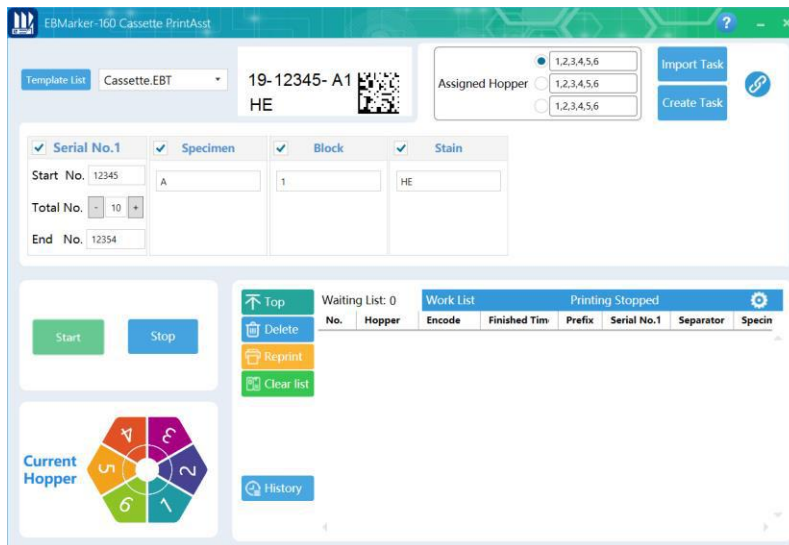



Figure 10-3

10.2.4 Enter the Printing Mode

Click the “  ” button to enter the printing mode.

10.2.5 Create Printing Task

Click the “  ” button, cassettes will be printed consecutively. The details of the generated tasks can be reviewed in the “Work List” below. As shown in Figure 10-4. Only under the printing mode, the tasks in the waiting list will be printed.

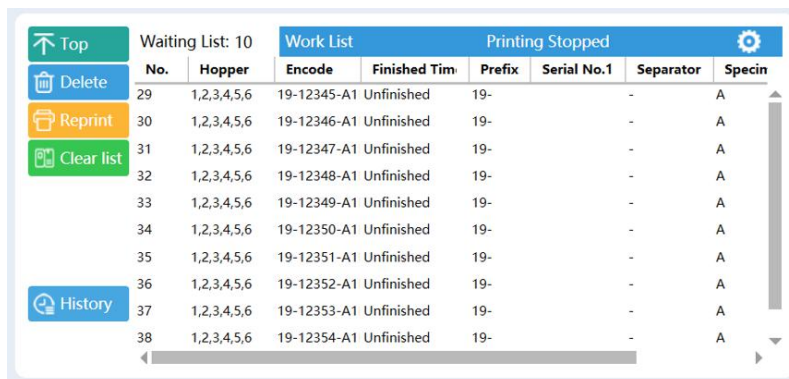

Figure 10-4

11.LIS Interface

11.1 Preparations

The EMarker-21A-C600 can interface with the Laboratory Information System (LIS) or other information management systems in order to eliminate the need for manual data entry, reduce the risk of errors, and streamline workflows.

The HealthSky printer software is designed to interface with LIS via files. Contact the relevant personnel of the Laboratory Information System before implementing the interface.

11.2 File-based Interface

The data is transferred in the form of a file. A “.txt” file or a “.xls” file containing the printing data will be generated by the LIS and saved to a certain path. The “.txt” file needs to be encoded in UTF-8. There can be multiple printing tasks in a file, one task shall be in one line. The generated file is then identified and processed by the *EMarker-21A-C600 PrintAsst*.

11.3 Interface

11.3.1 Parse the to-be printed content

The printing content generated by LIS generally includes “Year”, “Accession No.,” “Block No.” and other fields, which may be segmented by “\$”, “,” or other separators. Parse the content generated by clarifying the separator and the meaning of each field. Each field to be interfaced with is regarded as an “Editable Text”.

Take Figure 11-1 as an example. The left content is the data generated by the LIS. On the right is the required printing on the cassette. “2021” stands for the year, “12345” stands for the accession no., “01” stands for the block no. The separator is the “,”.

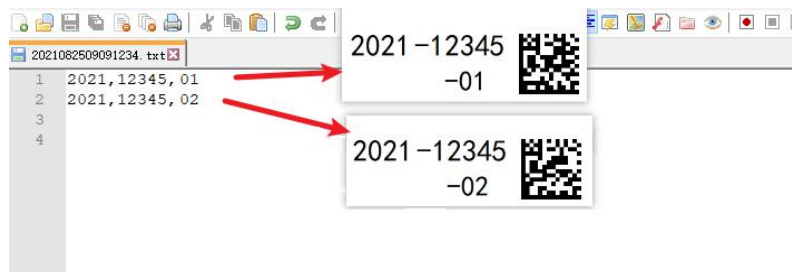

Figure 11-1

11.3.2 Create Template

- Add Editable Text

Each field to be interfaced with is regarded as an “Editable Text”. Add one or more “Editable text” based on the number of fields to be interfaced with. Set the length of each “Editable Text” to the maximum length of the field to be interfaced with. Add a “*” before the name of the added “Editable Text” to be interfaced with. As shown in Figure 11-2.

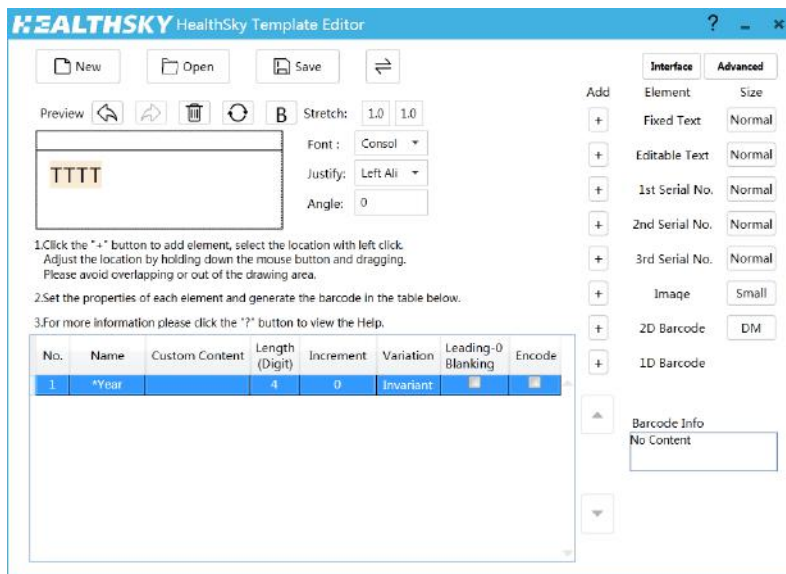

Figure 11-2

• Add Other Elements

Add other elements (such as separator or barcode as needed. As shown in Figure 11-3.

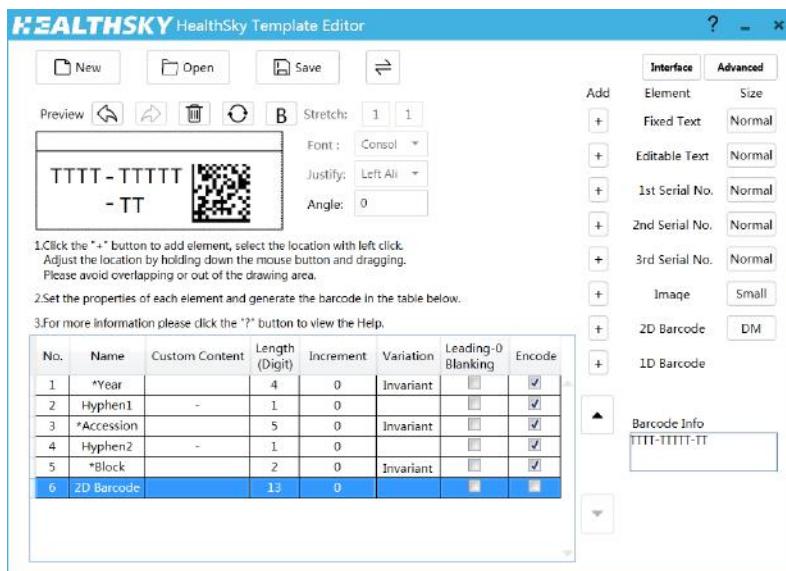

Figure 11-3

• Interface

Click the “Interface” button, check the “Separator” dialogue box, and enter the separator of the printing contents generated by the LIS. The separator is “,” in this case.

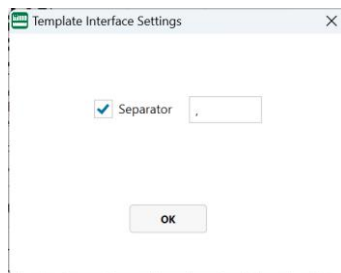

Figure 11-4

- **Save the Template**

Save the template to a certain path.

11.4 Print Test

Open the *EMarker-21A-C600 PrintAsst*, select the template created and open it.

Press the key combination “Ctrl+H+S” to open the advanced Settings.

Select the directory where the interface files are saved. If the interface file type is an excel file and there are multiple sheets in the file, the sheet name needs to be specified here. As shown in Figure 11-5.

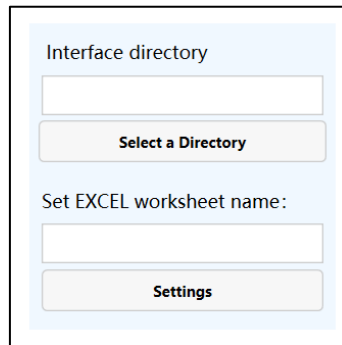

The screenshot shows a light blue dialog box with a black border. At the top, it is titled "Interface directory". Below the title is a white text input field. Underneath the input field is a grey button with the text "Select a Directory". Below the button is the text "Set EXCEL worksheet name:". Underneath this text is another white text input field. At the bottom of the dialog box is a grey button with the text "Settings".

Figure 11-5

Create a new .txt document on the computer desktop, change the content to “2021,12345,01”, save the file and copy it to the interface directory just set, a print task will be automatically generated.

11.5 Daily Print

Open the *EMarker-21A-C600 PrintAsst*, select the interface template, click the “Start” button to enter the printing mode, then minimize the window.

Select several tasks and click the “Print” button on the LIS, wait a few seconds, the printer will print out the selected tasks.

12. Trouble Shooting



- When cassette jam occurs, rectify the fault in time. Forcibly running the device may cause serious damage to the device.
- For inspection of lines or components by opening the enclosure, please contact after-sales service.

No.	Error Symptom	Possible Cause	Remedy
E1.1	The printer fails to reset when switched on.	No electricity or the switching circuit is faulty if the indicator light is not on.	Check whether the socket is powered on. Check whether the power cable is securely plugged in. Check whether the fuse has blown. If the printer still cannot be turned on, please contact the after-sales service.
E1.2		Internal fault of the printer if the indicator light is on.	Please contact the after-sales service.
E2.1	Abnormal noise occurs during reset.	Cassette stuck between the cassette hopper and cassette inlet.	Take down the cassette hopper at the cassette inlet carefully and avoid the cassette from falling into the device. Remove the cassette at the inlet if there is. Ensure that no cassette is protruding from the cassette hopper.
E2.2		The slider for pushing in or out the cassette is obstructed by a foreign object, or the path for pushing out the cassette is blocked by a foreign object.	Check if there are any foreign objects stuck at the cassette inlet. Inspect the cassette outlet and collection slot for any foreign objects. If found, use tweezers or other tools to remove them and then restart the device. If no foreign objects are found, please contact the after-sales service.
E3.1	Fail to connect.	The control software is not compatible with the device.	Ensure that the device model matches the software that is being opened.
E3.2		The connection cable driver is not installed or the connection cable is faulty	Reconnect the data cable securely. If the connection still fails, check the Device Manager on your computer system. If there is an exclamation mark icon next to the COM port related to the serial cable, it may indicate that the driver is not installed correctly and needs to be reinstalled. If no information appears for the COM port, the data cable might be damaged and should be replaced.
E3.3		The software is not running under Administrator status.	Close the software and re-open it after "Run as administrator" is checked, wait for 10 seconds and re-try. Please contact the after-sales service if the problem is still not solved.

E4	The software reports that the front motor or the rear motor is faulty and abnormal noise occurs during the printing process.	The slider for pushing in or out the cassette is obstructed by a foreign object, or the path for pushing out the cassette is blocked by a foreign object.	Check if there are any foreign objects stuck at the cassette inlet. Inspect the cassette outlet and collection slot for any foreign objects. If found, use tweezers or other tools to remove them and then restart the device. If no foreign objects are found, please contact the after-sales service.
E5.1	The software reported that there was no cassette, but the actual cassette was pushed in and out, the print area was blank.	Use a white paper to check whether the detection sensor of the print position is working normally. If the paper can be identified when it close to the sensor.	Wipe the sensor surface clean and try again. When the wiping is ineffective, it may be that the identification rate of the cassette is low. Replace the cassette with a type of cassette approved by the manufacturer.
E5.2		Use a white paper to check whether the detection sensor of the print position is working normally. If the paper cannot be identified when it close to the sensor.	Wipe the sensor surface clean and try again. When the wiping is ineffective, power off the device, open the access panel, check the cable connections to the sensor, and replace the sensor if necessary.
E6	The software reports cassette jam.	There is cassette stuck in the print position, does not fall in time and pushed out.	Turn off the device power, open the access panel, and check for and remove any debris at the cassette printing position.
E7.1	The print is mostly unclear or blank.	Unapplicable cassette.	Use the applicable cassette. Please contact the after-sales service if the problem is still not solved.
E7.2		The internal print area is obscured.	Turn off the device power, open the access panel, and check for and remove any debris at the cassette printing position.
E7.3		If the unclear position is the same in each printed area, it may be a galvanometer or field mirror fault.	Turn off the power of the device, open the access panel, borrow the light, and observe whether there is an area inside the field mirror that becomes opaque, and whether the mirror of the galvanometer is uniform in color. If nothing abnormal, check the connection line of the galvanometer and replace the galvanometer or field mirror if necessary.
E7.4		If the unclear position is different in each printed area, it may be a laser fault or a software fault.	Check the connection cables of the laser and the laser power supply module, and replace the laser if necessary.
E7.5		The color of the print is generally light, or blank	Replace the laser if necessary.
E8.1	The interface printing or scan to print contains no	No recognize feedback signal, such as sound or flicker, from the scanner.	Check the connection line of the scanner or replace the scanner, use the barcode in the template of the screen, and confirm that the

	content or incorrect content		scanner can send the feedback signal correctly when scanning the code.
E8.2		There is recognize feedback signal from the scanner, the task is not generated in the work list, no cassette is pushed in.	Possibly the template is incorrect. Verify that the used template is the one for interface. Verify that the encoding content, fields, and separator are correct.
E8.3		There are tasks in the work list, there are cassettes pushed in.	Refer to E7.1 to E7.5 for trouble shooting.
E8.4		The printed cassette is the previous print task. There's probably internal cassette retention.	When the device stops working, open the access panel, check and remove the stranded cassette.

13. Maintenance

13.1 Device Clean

13.1.1 Surface Clean

- 1) Turn off the power of the device and remove the consumables and consumable carrying parts.
- 2) Wet a soft cloth with clean water and wring it out until no water droplets fall naturally, use the cloth to clean the external plastic and metal parts of the device. Avoid water into the device.
- 3) Do not use organic solvents to wipe the plastic parts, as it may cause damage to the plastic surface.

13.1.2 Internal Clean

- 1) Remove the panel at the side of the device, use a soft brush to brush the inside of the printer to remove dust. As shown in Figure 13-1.

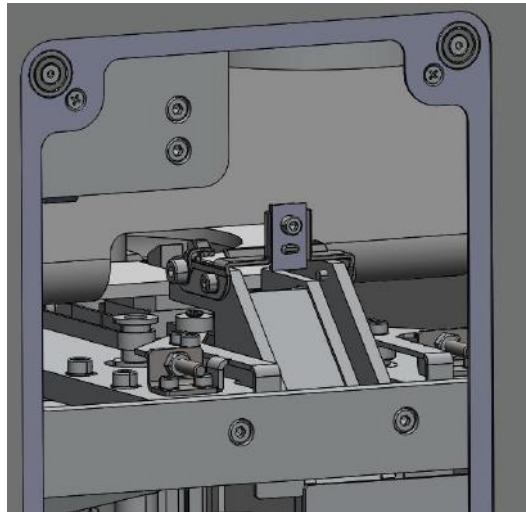

Figure 13-1

13.2 Changing Fuses



- Do not apply excessive force to the fuse, otherwise it may cause the fuse to break and cause injury.

To replace the fuses:

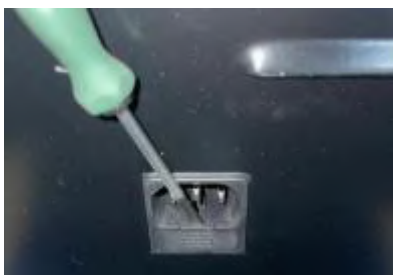

Switch off the power, unplug the power cord at the back of device, and use a slotted screwdriver to pry out the fuse holder on the power cord socket.



Bend the old fuse to both sides and take it out, snap the new fuse in from both sides, and put it back into the slot to complete the replacement.

Product Name: Multi Hopper Ultraviolet Laser Cassette Printer

Model: EMarker-21A-C600

Manufacture date and service life: please see the nameplate.



Hangzhou HealthSky Biotechnology Co., Ltd.

Room 302, Building No 1, Room 201, Building No 1-1, No.2073, Jinchang Road, Liangzhu Street,
Yuhang District, 311100 Hangzhou City, Zhejiang Province, PEOPLE'S REPUBLIC OF CHINA

Tel: +86 572 5020998

Fax: +86 572 5020991

e-mail: overseas@healthskybio.com

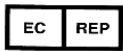

SUNGO Europe B.V.

Fascinatio Boulevard 522, Unit 1.7, 2909VA Capelle aan den IJssel, The Netherlands

文件编号：

文件名称：EMarker-21A-C600 User's Manual

版本号：A

编写：张马莉

审核：

批准：

生效日期：

2024-07-22

A 版变更内容如下：

- 1) 封面产品照片更新
- 2) P4 页 EMC 相关：根据实际外检标准与实际报告更新该章节
- 3) 1.1 章节：安全标识中增加激光辐射警告，电源开关符号说明，激光灼伤警告
- 4) 1.2 章节：安全预防措施使用栏中增加“确保包埋盒上的所有打印信息都经过彻底核实，以避免任何标签错误”的警示。
- 5) 3 参数章节：设备尺寸更改为 320×420×510 (mm)，重量更改为 24kg
- 6) 4.1.2 章节：增加“电源接口配有保险丝安装盒”的说明；增加电源线图示及说明。
- 7) 6.1.3 章节：更新工作台尺寸及重量要求
- 8) 6.4 章节：设备安装章节 文字提示改成黄色警告标提示
- 9) 6.5 章节：增加设备储存与运输说明
- 10) 8.3 章节：增加“确保包埋盒上的所有打印信息都经过彻底核实，以避免任何标签错误”的警示；增加激光安全相关提示
- 11) 12 章节：增加“出现卡包埋盒时，应及时排除故障。强行运行设备可能会导致设备严重损坏”警示；增加“打开外壳检查线路或部件，请联系售后服务”警示；根据中文版补充故障排除内容
- 12) 13.1.2 章节 图片更新
- 13) 13.2 章节：增加保险丝更换相关内容