

**HEALTHSKY**

**EMarker-11A-S100**

**Laser Slide Printer**

**User's Manual**



Hangzhou HealthSky Biotechnology Co., Ltd.

**CE**

Version: A

## Preface

### ■ Copyright

Hangzhou HealthSky Biotechnology Co., Ltd. (hereinafter referred to as “HealthSky”) owns the copyright of this Manual and the related software. Written permission from HealthSky is required before copying, reproducing, translating, or converting all or part of this Manual or the related software into electronic format or other device-readable formats.

### ■ Service Life

The service life of the device is at least five years from the date of completion of production. Please refer to the production date on the device label for the specific date.

### ■ Disposal

- The disposal of the device should be handled by collection facilities with qualifications for medical waste treatment.
- Infectious, pathological, and chemical waste may be present on the surface of the device.
- Complete disinfection can be achieved through methods such as microwaving, high temperature, and chemicals without secondary pollution, or incineration can be carried out. Materials that can be recycled, such as metal and glass, can be reused after complete disinfection.

### ■ Warranty

#### 1. Warranty Period

The warranty period is 12 months from the date of completion of installation.

#### 2. Warranty Coverage

- 2.1 If the user uses this device for the specified purpose and operates it according to the requirements of this Manual, HealthSky is responsible for free repair, and replacement of parts or products for users within the warranty period when the device cannot be operated normally due to the quality problems.
- 2.2 The consumable parts of this device (such as filters) are not included in the warranty coverage.
- 2.3 Maintenance out of the warranty period are chargeable service. Corresponding fees are charged based on the parts that need to be replaced, labor costs, and travel expenses.

#### 3. Disclaimer

- 3.1 The interface may vary with the versions of the software. The figures provided in this Manual are for illustration, please refer to the actual interface.
- 3.2 Users must receive adequate training before operating the device and be fully aware of the potential dangers or hazardous steps.
- 3.3 Only trained and authorized personnel and only under the provisions of this Manual are allowed to remove any protective covers or parts of the device.
- 3.4 Maintenance must be performed only by qualified maintenance personnel authorized by HealthSky.
- 3.5 HealthSky will not be liable for any of the following:
  - 1) Failures caused by usage outside the conditions specified in this Manual.
  - 2) Failures caused by usage outside the service life of the device specified in this Manual.

- 3) Failures caused by the user's non-compliance with the operation requirements specified in this Manual.
- 4) Failures caused by improper operation and mis-operation of the user.
- 5) After installation and commissioning, failures caused by movement, transportation, or installation in ways other than those specified in this Manual.
- 6) Failures caused by disassembly, re-debugging (except load calibration), or modification of device components without authorization.
- 7) Failures caused by fire, earthquake, wind damage, flood, lightning strike, crime, terrorist activities, war, or other irresistible forces.
- 8) Failures caused by maintenance of the device by personnel not authorized by HealthSky, or failures caused by not maintaining the device by the instructions provided in this Manual.
- 9) Failures caused by not replacing consumable parts with a specified usage period on time
- 10) Failure caused by using hardware, software, consumables, or accessories not specified by HealthSky.
- 11) Failures occurring in devices that have been scrapped or in second-hand devices.

## ■ EMC Declaration

- The Device complies with the Emission and Immunity requirements specified in EN IEC 61326-1, EN IEC 61326-2-6.
- The Device is designed and tested according to EN IEC 61326-1, CISPR 11 Group 1, Class A equipment. In home environment, the Device may cause radio interference.
- User has the responsibility to ensure EMC environment so that the Device can function properly.
- Do not use the Device near a strong radiation source, such as an unshielded RF source, as this may interfere with the proper function of the Device.
- It is suggested to evaluate the electromagnetic environment before use of this Device.

**Chart 1 Disturbance voltage limits for class A group 1 equipment  
measured on a test site (a.c. mains power port)**

Test Item	EMC Standard	Type	Limit		
			Frequency Range (MHz)	Rated power $\leq 20$ kVA Quasi-peak value dB ( $\mu$ V)	Average value dB ( $\mu$ V)
Disturbance Voltage	CISPR 11	Group 1 Class A	0.15~0.50	79	66
			0.50~30	73	60

**Chart 2 Electromagnetic radiation disturbance limits for class A group1 equipment  
measured on a test site**

Electromagnetic radiation disturbance	EMC Standard	Type	Frequency Range (MHz)	3 m measuring distance Rated power $\leq 20$ kVA	
				Quasi-peak dB ( $\mu$ V/m)	
Electromagnetic radiation disturbance	CISPR 11	Group 1 Class A	30~230	50	
			230~1000	57	

**Chart 3 Immunity test requirements for equipment intended  
to be used in PROFESSIONAL HEALTHCARE FACILITY ENVIRONMENT**

Port	Phenomenon	Basic Standard	Test Value	Performance Criterion
Enclosure	Electrostatic Discharge	IEC 61000-4-2	± 4 kV contact	B
			± 2 kV, ± 4 kV, ±8 kV air	B
	Electromagnetic field	IEC 61000-4-3	3V/m (80 MHz to 6 GHz)	A
	Power frequency magnetic field	IEC 61000-4-8	3A/m, (50 Hz, 60 Hz)	A
AC power (including protective earth)	Burst	IEC 61000-4-4	± 1 kV (5 kHz or 100 kHz)	B
	Surge	IEC 61000-4-5	± 0.5 kV line-to-line	B
			±1 kV line-to-ground	B
	Conducted RF	IEC 61000-4-6	3 V (150 kHz to 80 MHz)	A
	Voltage dip	IEC 61000-4-11	0% during 0.5 cycles	B
0% during 1 cycle 70% during 25/30 cycles <sup>a</sup>			B C	
Short interruptions	IEC 61000-4-11	0% during 250/300 cycles <sup>a</sup>	C	
DC power (including protective earth)	Burst	IEC61000-4-4	± 1 kV (5 kHz or 100 kHz)	N/A
	Surge	IEC61000-4-5	± 0.5 kV line-to-line	N/A
			±1 kV line-to-ground	N/A
Conducted RF	IEC61000-4-6	3 V (150 kHz to 80 MHz)	N/A	
I/O signal/control (including functional earth)	Burst	IEC61000-4-4	± 0.5 kV (5 kHz or 100 kHz)	N/A
	Surge	IEC61000-4-5	±1 kV line-to-ground	N/A
	Conducted RF	IEC61000-4-6	3 V (150 kHz to 80 MHz)	N/A
I/O signal/control connected directly to mains supply	Burst	IEC61000-4-4	± 1 kV (5 kHz or 100 kHz)	N/A
	Surge	IEC61000-4-5	± 0.5 kV line-to-line	N/A
			±1 kV line-to-ground	N/A
Conducted RF	IEC61000-4-6	3 V (150 kHz to 80 MHz)	N/A	

<sup>a</sup> For example, "25/30 cycles" means "25 cycles for 50 Hz test" or "30 cycles for 60 Hz test".

## CONTENTS

<b>1. Important information .....</b>	<b>7</b>
<b>2. Product Information .....</b>	<b>11</b>
<b>3. Specification.....</b>	<b>12</b>
<b>4. System Description.....</b>	<b>13</b>
<b>5. Packing List .....</b>	<b>24</b>
<b>6. Device Installation.....</b>	<b>25</b>
<b>7. Software Setup.....</b>	<b>27</b>
<b>8. Daily Operation .....</b>	<b>35</b>
<b>9. HealthSky Template Editor .....</b>	<b>37</b>
<b>10. EMarker-11A-S100 Print Asst.....</b>	<b>42</b>
<b>11. LIS Interface.....</b>	<b>44</b>
<b>12. Scan to Print .....</b>	<b>47</b>
<b>13. Trouble Shooting.....</b>	<b>50</b>
<b>14. Maintenance .....</b>	<b>53</b>

## 1. Important information

Thank you for choosing the HealthSky EMarker-11A-S100 Laser Slide Printer!

This Manual provides the features, principle, structure, installation, operation, troubleshooting, maintenance, and safety precautions of the device.

Please read the HealthSky EMarker-11A-S100 Laser Slide Printer User's Manual completely before use.

Please contact HealthSky or HealthSky authorized distributor for any help you need.

### 1.1 Safety Symbols

#### 1.1.1 The Symbols used in this manual



Warnings: which may cause personal injury.



Cautions: which may cause device damage or unsatisfactory results.



Caution: Possible laser radiation.

#### 1.1.2 The Symbols used on the device:



Protective Ground



Power On



Power Off



Serial Number



Date of Manufacture



Use by



Manufacturer



European Authorized Representative



Consult instructions for use



Country of Manufacture



The device is fully in conformance with the Regulation (EU) 2017/746 of the European Parliament and of the Council.



In Vitro Diagnostic Device



The symbol indicates that the product should not be discarded as unsorted waste but must be sent to separate collection facilities for recovery and recycling.



Caution: Possible laser radiation.



Class 4 laser product.



Avoid eye exposure to direct or scattered radiation.



Avoid skin exposure to direct or scattered radiation.



## 1.2 Safety Precautions

To ensure the safe operation of the device, the following instructions and warnings must be followed:

### Intended Use



- The EMarker-11A-S100 is designed for use in pathology, histology, cytology, and similar laboratories, and can only be used for printing microscope slides.  
Do not use the product for other purposes.

### Users



- For use by Trained Laboratory Personnel.
- Training by HealthSky or HealthSky authorized distributor is required before operating the device.

### Environment



- The device shall be installed and operated under environmental conditions that meet the standard operating requirements specified in this Manual. Installing and operating the system in the other environment may cause device damage.
- Keep away from water sources, high-power electrical device, and strong magnetic interference fields.
- It is the responsibility of the user to ensure the electromagnetic compatibility environment for the device.

### Installation and Relocation



- Only transport the device upright. Tilted transportation may cause device damage or even personnel injury.
- The device should be placed on a stable and level workbench to avoid shaking when it is running.



- Do not stack the device during relocation or storage.
- Please refer to **Chapter 6 Device Installation** before installation or relocation.



- The device may be shaken, tilted or lifted during transportation, the slide magazine must be removed and secured prior to each transport, otherwise, the device may be damaged.

### Slide



- Only use the compatible slide specified in this manual. Incompatible slides may cause poor printing or device damage.

### Before Operating the Device



- Read the EMarker-11A-S100 Laser Slide Printer User's Manual completely before use.
- Please keep this Manual properly and ensure that it is accessible at any time when needed.

### Operating the device



- Do not touch the moving parts of the device with your hands or other body parts during the operation to avoid physical injury.
- Power off the device before removing the protective cover. Do not operate the device or observe the inside of the device while the protective cover is removed. Any of the above actions may cause personal injury.



- Good laboratory practices should be followed.
- Operate the device strictly as instructed by this Manual. Inappropriate operation may lead to poor printing or even device damage.
- Load the slides strictly as instructed by this Manual. Make sure the slides are loaded in the right direction.
- Discard the slides that are printed incorrectly in time to avoid subsequent problems caused by misuse.
- Make sure that all printed information on slides is thoroughly verified to avoid any labeling errors.
- Do not take out the slide magazine or components when the device is running. Stop the printing task before operating the slide magazine.
- Make sure no obstruction blocking the slide outlet. Blocking will cause serious failures.
- If the device loses power suddenly, please keep it in its current state with no manual adjustment. The device will automatically reset when the power is restored. Improper operation during the power failure may cause a reset failure.

### After Operation



- Please turn off the power after use. It is recommended not to leave the device on standby for a long period.

### Cleaning



- Turn off the power before cleaning the device.
- Clean the device strictly as instructed by this Manual. Inappropriate operation may lead to poor printing or even device damage.
- Do not get water or other liquids into the device. Use a dry or a damp cloth that does not drip when cleaning.

### Maintenance



- Maintenance should be carried out in strict accordance with the provisions in **Chapter 14 Maintenance**.
- Only qualified maintenance personnel authorized by HealthSky are allowed for maintenance and repair.

## 2. Product Information

### 2.1 Introduction

The EMarker-11A-S100 Laser Slide Printer is a printing device developed by Hangzhou Healthsky Biotechnology Co., Ltd. that can leave permanent marks on the writing surface of the microscope slides.

EMarker-11A-S100 utilizes laser printing technology to create crisp, permanent, and high-resolution markings at high speed.

The printer is equipped with one slide magazine, maximum capacity of a single filling is 100 pcs of slides.

A portable slide cartridge can be inserted below the outlet, which can store about 30 slides at a time.

EMarker-11A-S100 supports the printing of alphanumeric, symbols, graphics, linear and two-dimension barcode encoding and printing.

Supported by the user-friendly *HealthSky Template Editor* and *EMarker-11A-S100 PrintAsst.* EMarker-11A-S100 delivers efficient and quality on-demand and batch printing and enables workflow optimization.

### 2.2 HealthSky Template Editor

HealthSky Template Editor is used to design templates using texts, serial numbers, icons, and barcodes. It allows users to create the design from the start or by editing the template by freely adding, deleting or moving the text, serial number, icon and other available elements as well as changing their properties like font, font size, rotation and more.

### 2.3 EMarker-11A-S100 PrintAsst.

EMarker-11A-S100 PrintAsst. manages the running of the printer, as well as operation and data processing. It is used to select templates, edit the printing data, sequence, and perform daily print tasks.

### 3. Specification

Model	EMarker-11A-S100
Compatible Slide	Color frosted slides with laser absorber Slide dimension: Length $\leq 76.2$ mm, width $\leq 25.7$ mm, thickness $1.1 \pm 0.1$ mm.
Printing Technology	Non-Contact Infrared Laser
Print Head	1
Print Color	Black to Gray
Print Content	Alphanumeric, 1D/2D barcodes, Graphics, Symbols
Single Print Speed*	$\leq 4$ seconds
Batch Print Speed*	$\leq 400$ seconds /100 pcs
Resolution	2500 dpi
Slide Capacity	100 pcs maximum
Loading Access	1
Single Feeding Capacity	1 pcs/access
Operation & Display	PC
Operating System	Windows11, Windows10, Windows 7, x64/x86; Windows XP
Data Interface	USB
System Interface	LIS, LIMS, HIS, PIS, PACS
Supported Encoding Data	Texts, Numeric, Alphabets, Basic symbol
Auxiliary Functions	Dust Filter, Scan to print, Repetitive task reminder, Running fault alarm
Supply Voltage	100-240 VAC, 50/60 Hz
Dimension (L $\times$ W $\times$ H)	220 $\times$ 420 $\times$ 380 (mm)
Weight	15 kgs

\*The Print Speed may vary depending on the printing contents.

## 4. System Description

### 4.1 Hardware

#### 4.1.1 Front View

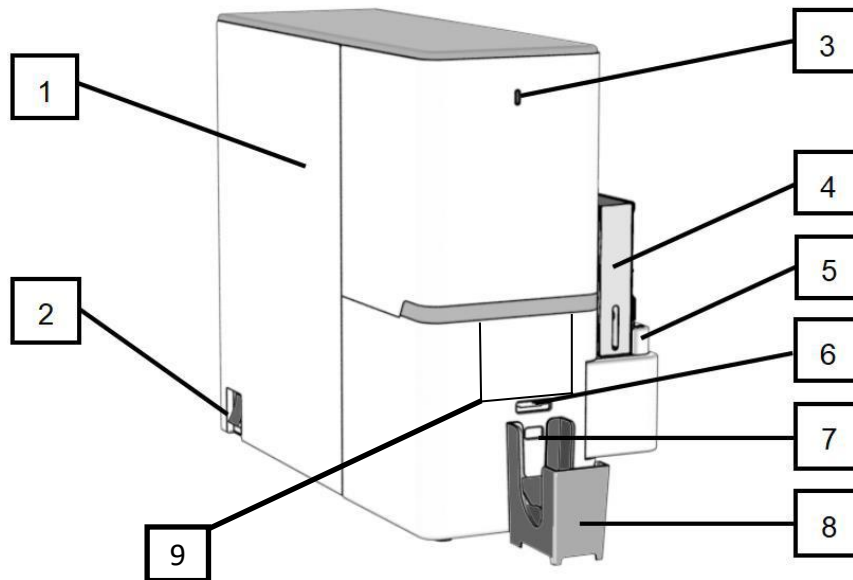

Figure 4-1 Front View

1. Mainframe: the mainframe consists of a laser device, a scanning galvanometer, and a control panel.
2. Power Switch: for power control.
3. Indicator: blue indicates normal running and red indicates fault.
4. Slide Magazine: a container that can hold the slides.
5. Magazine Holder: the slide magazine can be inserted into the holder.
6. Slide Outlet: from where the slides are pushed out, one slide at a time.
7. Detector: used to detect the loading status of the slide cartridge. When the cartridge is full, the program will prompt.
8. Slide Cartridge: used to collect the slides that are pushed out after printing.
9. Front Door Panel: the panel can be opened to examine the slide in-and-out status if there is problem.

### 4.1.2 Back View

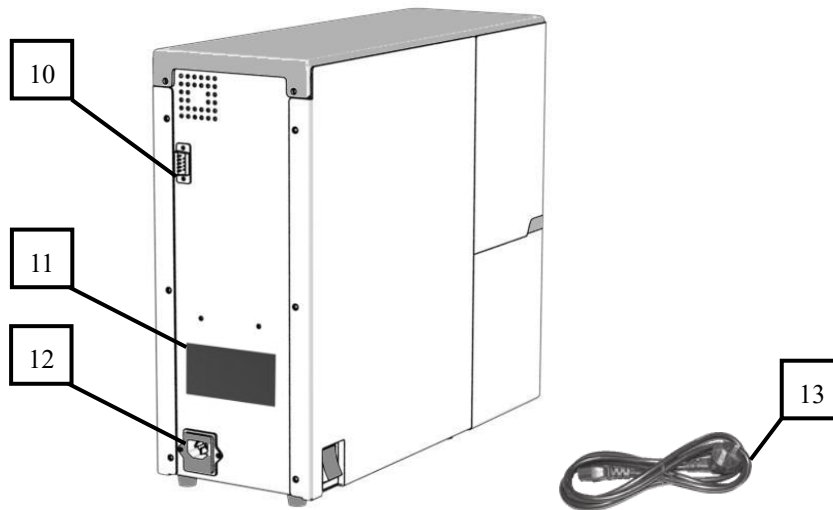

Figure 4-2 Back View

10. DB9 Port: used for wired connection to realize data exchange between the printer and the control terminal (PC).
11. Nameplate: contains basic information about the device and the manufacturer's contact information.
12. Power Port: for power entry. The power port is equipped with a fuse installation box.
13. Power Cable: connects the external power supply to the mainframe.

## 4.2 HealthSky Template Editor Interface

Templates determine how the data are printed.

*HealthSky Template Editor* is used to design templates using texts, serial numbers, icons, and barcodes. It allows users to create the design from the start or by editing the template by freely adding, deleting or moving the text, serial number, icon and other available elements as well as changing their properties like font, font size, rotation and more.

The template can also be designed to interface with laboratory information management system or accept data from scanned barcodes.

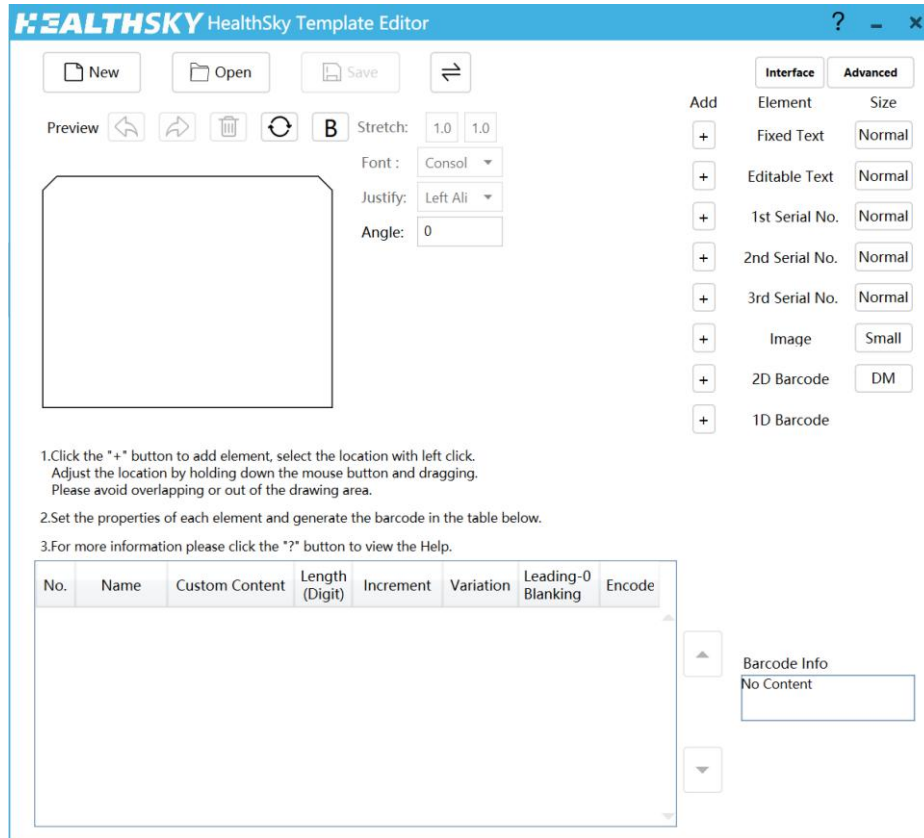

Figure 4-3 HealthSky Template Editor Interface



### View Help

Click the button to enter the help page, and then click the “View Help” button to view the detail instructions on the operation of the software.



### Create Template

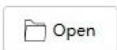

### Open Template



### Save Template



### Switch between the Cassette Template and Slide Template

Click the button to switch between the template for cassette and slide.



### Undo

Operations that add, delete, move, or modify elements can be undone.



### Redo

Operations that add, delete, move, or modify elements can be redone.



**Delete**

Click the button to delete the selected element.



**Switch the Template Direction**

The printing direction of the template is settable. Click the button to switch the printing direction. The printing direction of the cassette can rotate at 0° and 180°, and the printing direction of the microscope slide can rotate at 0°, 90°, 180°, and 270°.



**Font Bold**

Click the button to make the selected font bold. Icons and Barcodes do not support this function.



**Stretch**

Select the non-icon elements, and change the value in the edit box to make the elements stretched. The stretch value can be changed by hovering over the edit box and using the scroll wheel to change it.



**Font**

Click the dropdown to change the element font.



**Justify**

Click the dropdown to change the alignment of the elements. The software supports top alignment, bottom alignment, left alignment, right alignment, horizontal center alignment, and vertical center alignment of selected elements. Select elements in the table below, and press the shortcut key to align the selected elements.



**Angle**

The rotation angle of the element. For example, the element in the picture on the right is rotated 9 degrees.



**Display Window**

The place where the print content and print layout are designed and previewed.



### Element Property Setting Window

No.	Name	Custom Content	Length (Digit)	Increment	Variation	Leading-0 Blanking	Encode
1	Prefix	19-	3	0		<input type="checkbox"/>	<input type="checkbox"/>
2	Accession		5	1	Auto-incre	<input checked="" type="checkbox"/>	<input type="checkbox"/>
3	Separator	-	1	0		<input type="checkbox"/>	<input type="checkbox"/>
4	Specimen	A B C	1	0	Clear	<input type="checkbox"/>	<input type="checkbox"/>
5	Block	1 2 3 4 5 6	1	0	Invariant	<input type="checkbox"/>	<input type="checkbox"/>
6	Stain	H+	2	0	Invariant	<input type="checkbox"/>	<input checked="" type="checkbox"/>

**Name:** to name the added element.

**Custom Content:** to input content for fixed text or editable text.

**Length (Digit):** to set the digit length limitation of the element.

**Increment:**

The “Increment” is only applicable for the “Serial No.”

It is the increased value of the “Serial No.”

When the value is 1, the serial no. increase by 1 after each printing.

The value ranges from 1 to 255 (and cannot exceed the upper limit of the digit length set). For example, the maximum incremental value of a one-digit serial number is 9.

**Variation:**

The “Variation” function can be used to set the change rules for the “Editable Text”, and the “Serial No.” after the print task is generated. “Invariant” and “Empty” options are available for “Editable Text”. “Invariant”, “Auto-increment”, and “Back to 1” are available for the “Serial No.”.

**Leading-0 Blanking:**

The “Leading-0 Blanking” is only applicable for the “Serial No.”.

Zeros appearing to the left of the first non-zero digit of the serial no. will be omitted or replaced with blanks after the selection box is checked.

**Encode:**

“Fixed Text”, “Editable Text”, and “Serial No.” are supported for barcode generation.

Click the selection box of the “Encode” column and the corresponding element will be used to generate the barcode.



**Interface**

Click to interface with Laboratory Information System (LIS) or other laboratory information system. Refer to **Chapter 11 LIS Interface** for operation instructions.



**Advanced**

Save the script file to the template through the button to realize more customized content in the *EMarker-11A-S100 Print Asst.* software. Contact the after-sales service for more detailed information.

- Fixed Text
- Editable Text
- 1st Serial No.
- 2nd Serial No.
- 3rd Serial No.
- Image
- 2D Barcode
- 1D Barcode

**Add Element**

Left click the “+” button in front of the element.

Select a location in the display window, left click to add the element.

**Fixed Text**

The “Fixed Text” can be used as fixed content, such as the year, the laboratory name, or the separator.

**Editable Text**

The “Editable Text” can be used for application scenarios when the printing content requires to be edited on-site, such as the date, the specimen no., the block no., the stain type etc.

**Serial No.**

The “Serial No.” can be used for application scenarios when a series of tasks need to be created, such as the accession no., slide no. etc.

**Image**

The “Image” can be used to import images for printing.

**2D Barcode**

The “2D Barcode” can be used to generate a QR Code or a DataMatrix Code.

**1D Barcode**

The “1D Barcode” can be used to generate the Code128A.



**Normal**

Click the button to switch between the conventional font and the flat font. The conventional font can be used for the content on the writing surface. The flat font can be used for the content on the thin bar.



**Small**

Click the button to switch between small and large images.



**QR**

Click the button to switch between the QR code and the Datamatrix code.



**Encoding Order Adjustment**

The encoding order is adjustable by adjusting the order of the elements. Adjust the order by clicking the two buttons.



**Barcode Info Preview**

The encoded content could be previewed.

Refer to **Chapter 9 HealthSky Template Editor** for detail instructions on the operation.

### 4.3 EMarker-11A-S100 PrintAsst. Interface

#### 4.3.1 Main Interface

EMarker-11A-S100 PrintAsst. manages running of the printer, as well as operation and data processing. It is used to select templates, edit the printing data, sequence, and perform daily print tasks.

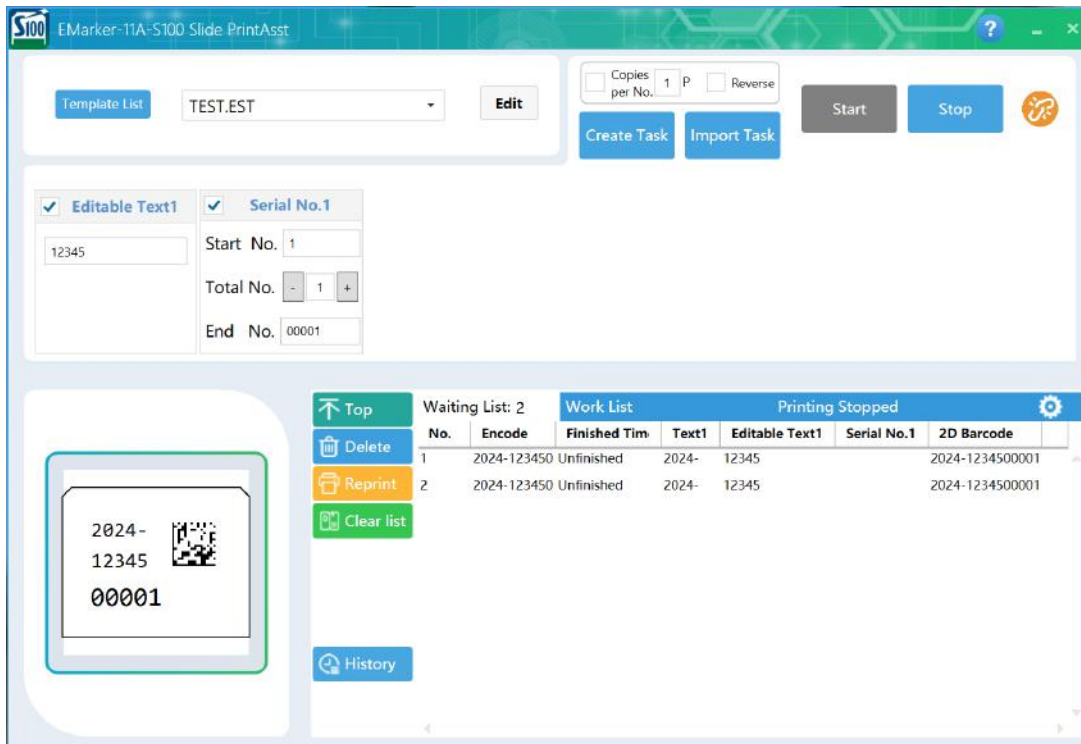

Figure 4-4 EMarker-11A-S100 PrintAsst. Interface



**View Help**

Click the button to enter the help page, and then click the “View Help” button to view the detailed instructions on the operation of the software.



**Template List**

Click the button to select a template for printing.



**Template Name**

The name of the currently opened template name. Click the drop-down arrow to view the template list.



**Edit**

Click the button to switch between the “Input to print” mode and “Scan to print” mode.



**Scan**

Click the button to switch between the “Input to print” mode and “Scan to print” mode.



**Copies per No.**

Check the check box and enter the number, multiple copies of each printing task will be printed.

Copies per No.  P  Reverse



**Reverse**

After the check box is checked, the printing tasks will be printed in reverse order.



**Import Task**

Click the button to import the printing tasks.

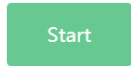

**Create Task**

Click the button to create the printing tasks.



**Start**

Click the button to enter the printing mode.



**Printing**

The “Start” button converts to the “Printing” button after it is clicked. It indicates the printer is under the printing mode.



**Stop**

Click the button to exit the printing mode.



It indicates that the printer doesn’t connect to the PC.

<input checked="" type="checkbox"/> Editable Text1	<input checked="" type="checkbox"/> Serial No.1
<input type="text" value="12345"/>	Start No. 1
	Total No. 1
	End No. 0001

It indicates that the printer connects to the PC successfully.



**Task Editing Area**

The “Editable Text” and “Serial No.” in the template will be displayed here in order. Enter the content for printing. The starting number, number of prints, and end number can be set for the “Serial No.”.

Check the check box in the upper left corner of each element to determine whether the element is to be printed.



**Template Preview**

The preview of the opened template.



**Top**

Click the button to top the selected printing tasks.



**Delete**

Click the button to delete the selected printing task.



**Reprint**

Click the button to reprint the selected printing task.

**Clear list**

Once click the button, finished & unfinished printing task will be cleared.

No.	Encode	Finished Tim	Surgical Case	Year	Hyphen
6	S23-000003B	2:51:51 PM	5	23	-

### Waiting List/Work List

The completed tasks are displayed in green, the uncompleted tasks are displayed in black. The number of remaining tasks is displayed as the “Waiting List”.



### History

Click the button to review the history printing task.

Start Date    
 End Date

Click “Start Date” & “End Date” to expand the range of history printing task records.

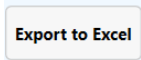

### Export to Excel

Click the button to export the printing history as an Excel file.

## 4.3.2 Work list organizing

Click the “” button to order, and display/hide the columns of the “Work List”. The settings of the “Work List” are associated with the template. The settings are automatically loaded after the template is opened.

No.	Encode	Finished Tim	Surgical Case	Year	Hyphen	Accession No.	Specime
6	S23-000003B	2:51:51 PM	5	23	-		

Figure 4-5

Table columns can be moved left, right, hidden, and displayed. As shown in Figure 4-6.

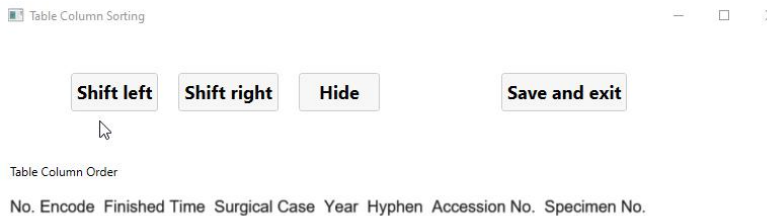

Figure 4-6

## 4.3.3 Printing Parameters Settings

Press the key combination “Ctrl+H+S” to open the advanced Settings. As shown in Figure 4-7.

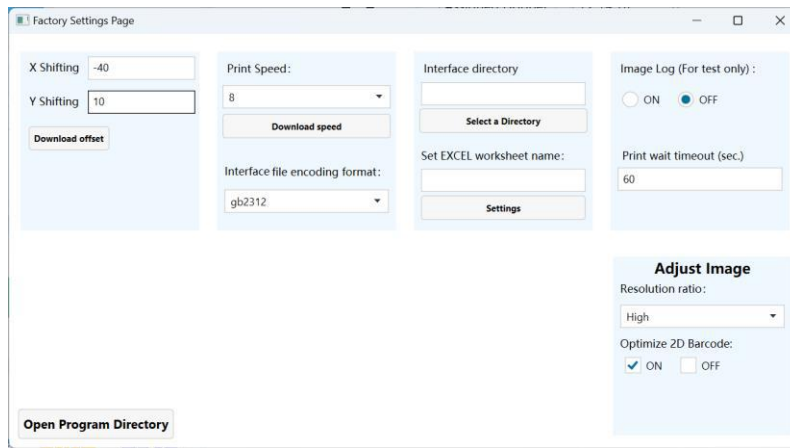

Figure 4-7

#### 1) Printing Layout Adjustment

When the actual printing layout is different from the template layout, adjust the value of the “X Shifting” and “Y Shifting”, click the “Download offset” button, then test the printing.

#### 2) Printing Speed

The printing speed can be set by adjusting the “Print Speed” value. The higher the value, the faster the speed and the lighter the print color. After setting the value, click the “Download speed” button to complete the setting.

#### 3) Interface File Encoding Format

Interface file encoding format supports gb2312, utf-7, utf-8, utf-32, utf-16, us-ascii.

#### 4) Interface Directory

When interface with laboratory information system, select the directory where the interface files are saved.

#### 5) Set EXCEL Worksheet Name

When the interface file type is an excel file and there are multiple sheets in the file, the sheet name needs to be specified here. The default is the first worksheet.

#### 6) Image Log (For test only)

The Image log recording switch is usually turned off. It can be turned on when after-sales personnel need to view the Image log. After turning it on, Image screenshots of each print task will be generated in the software installation directory/Image, as shown in Figure 4-8.

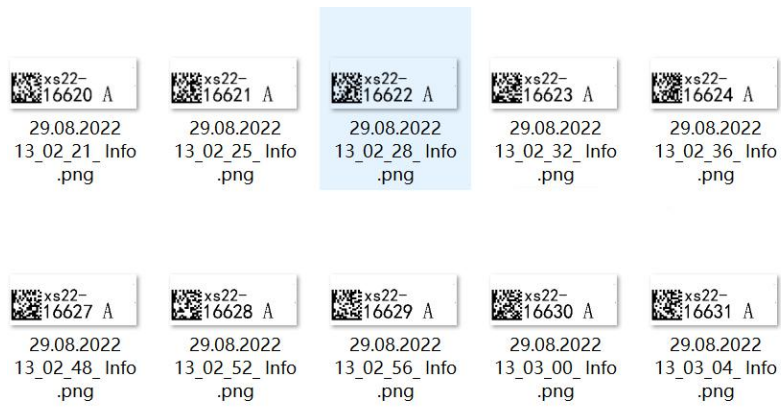

Figure 4-8

#### 7) Print Wait Timeout (sec.)

When the printing task is not completed within the time specified in the dialog box, the printing will suspend and a reminder will pop-up.

#### 8) Adjust Image

The default state of Resolution ratio is normal, and the default state of Optimize 2D Barcode is on. If any adjustment is needed, please contact the after-sales personnel.

## 5. Packing List

No.	Item	Model	Quantity(pcs)
1	Laser Slide Printer	EMarker-11A-S100	1
2	Slide Magazine		1
3	Slide Cartridge		1
4	USB to DB9 Adapter Cable		1
5	Power Cord		1
6	Fuse	TBC T2AL250V	2
7	User's Manual		1
8	QC Certificate/Inspection Report		1
9	Warranty Card		1



## 6. Device Installation



- Installation of the EMarker-11A-S100 can only be performed by HealthSky authorized personnel.

The user should prepare the proper site for installation. The device shall be installed by HealthSky authorized personnel only.

### 6.1 Site Preparation



- The device must be installed and operated under environmental conditions that meet the standard requirements specified in this manual. Installing and operating the system in other environment may cause poor printing or even device damage.

#### 6.1.1 Power Requirements

- 1) Power supply: AC 100-240V, 50/60Hz, 300VA, three-wire power cord and properly grounded.
- 2) The system should be connected to a properly grounded power socket.
- 3) The distance between the power socket and the system should be less than 1.5 meters.

#### 6.1.2 Environmental Conditions

- 1) Indoor Use only.
- 2) Altitude: up to 2,000 m (6,562 ft).
- 3) Temperature: between 5~40°C.
- 4) Humidity: maximum relative humidity 80% is for temperature up to 31 °C, relative humidity decreases linearly to 50% at 40 °C.
- 5) Supply voltage fluctuation:  $\leq \pm 10\%$  of the nominal voltage.

#### 6.1.3 Workbench Requirements

- 1) Horizontal workbench with sufficient rigidity.
- 2) If a movable bracket or trolley is used, a locking device should be used.
- 3) Workbench loading capacity:  $\geq 15$  kg.
- 4) Workbench dimension: length  $\geq 420$  mm, depth  $\geq 620$  mm.

#### 6.1.4 Space Requirements

Leave necessary space around the device when installing it.



- Leave necessary space around the device to ensure the heat dissipation of the device.

- 1) Leave at least 100 mm of space on the left and right sides of the device.
- 2) Leave at least 100 mm of space in front of the device.

- 3) Leave at least 100 mm of space at the back of the device. Ensure that the vents are unblocked.
- 4) Leave space for the PC which is used to control the device.

## 6.2 Unpack the Device

- 1) Carefully inspect the package of the device when receiving it. Any signs of mishandling or damage, please contact HealthSky or the authorized distributor immediately.
- 2) Check the goods per the packing list after unpacking, if anything missing or damaged, please contact HealthSky or the distributor immediately.

## 6.3 Carrying the Device

- 1) When carrying the device, it is necessary to lift from the left and right sides of the device and balance the force.
- 2) Please carry the device vertically and do not shake it.
- 3) When transporting the device or for long-distance, please use the original package. Properly fix the device firmly keep it in a vertical state and handle it with care.



- Risk of injury while lifting and carrying heavy loads.
- Lifting and transporting of the device should be done with a sufficient number of helpers. Use a transport aid for transporting the device.

## 6.4 Install the Device

- 1) Connect one end of the power cable to the power port and the other end to the socket.
- 2) Use the USB to DB9 Adapter Cable to connect the printer and the computer.
- 3) Insert the slide magazine into the slot of the magazine holder.
- 4) Turn on the printer.



- If there is a large temperature difference between the warehouse and the installation site and the air humidity is high, condensation may form inside the device. In this case, wait for at least two hours before turning on the device, otherwise, the device will be damaged.

## 6.5 Storage and Transportation

- 1) For indoor storage.
- 2) The maximum stacking number is 2 when using the original packaging.
- 3) Storage and transportation conditions:

Temperature: -20°C to 55°C

Humidity: maximum relative humidity 80% (non-condensation)

Air pressure: 50~106 kPa

- 4) During transportation, please keep the device upright and avoid prolonged exposure to sunlight and moisture.

## 7. Software Setup

### 7.1 Hardware Requirements

	Minimum Requirements
Processor:	1.8 GHz processor
Memory:	2GB
Storage:	Solid State Drive (SSD) 300MB available space
Resolution:	1024*768 minimum display resolution
Input:	Keyboard and mouse required

### 7.2 System Requirements

Windows operating system (Windows XP SP3 or above) installed with .NET Framework4.0 or later. If only the service framework is missing, install it during the subsequent software installation.

If the operating system is the ghost version, install the complete set of control software in advance and confirm whether the software can run successfully.

### 7.3 Software Installation

#### 7.3.1 Preparation for Installation

1) Copy the EMarker-S100 Installer Package

For computers that support software installation with a USB flash drive, copy the EMarker-11A-S100 Installer Package to the computer for installation.

When authority or approval is required to install software, please contact the management first.

2) Unzip the EMarker-C100 Installer Package. The following files are contained in the unzipped folder.

Name	Type	Size
Running Essentials	File folder	
EMarker-S100-V1.12.00.4.exe	Application	9,801 KB
TemplateEditor-V1.0.4.exe	Application	5,639 KB

Figure 7-1

#### 7.3.2 Running Essentials

Open the “Running Essentials” folder, as shown in Figure 7-2.

Name	Date modified	Type	Size
CDM212364_Setup.exe	2021/7/12 13:11	Application	2,212 KB
dotNetFx40_Full_x86_x64.exe	2019/5/13 10:15	Application	49,268 KB

Figure 7-2

##### 1) Install the .NET Framework

.NET Framework 4.0 and above is required for the software installation.

The user can double-click the “dotNetFx40\_Full\_x86\_x64.exe” file contained in the folder to install the .NET Framework.

If the computer is already installed with the .NET Framework 4.0 or a later version, after clicking the file, a reminder will

be displayed. Please skip to the next step.

## 2) Install the Serial Driver

- Double click the “CDM212364\_Setup.exe” file to install the serial driver. Click “Extract” during the installation process. As shown in Figure 7-3.

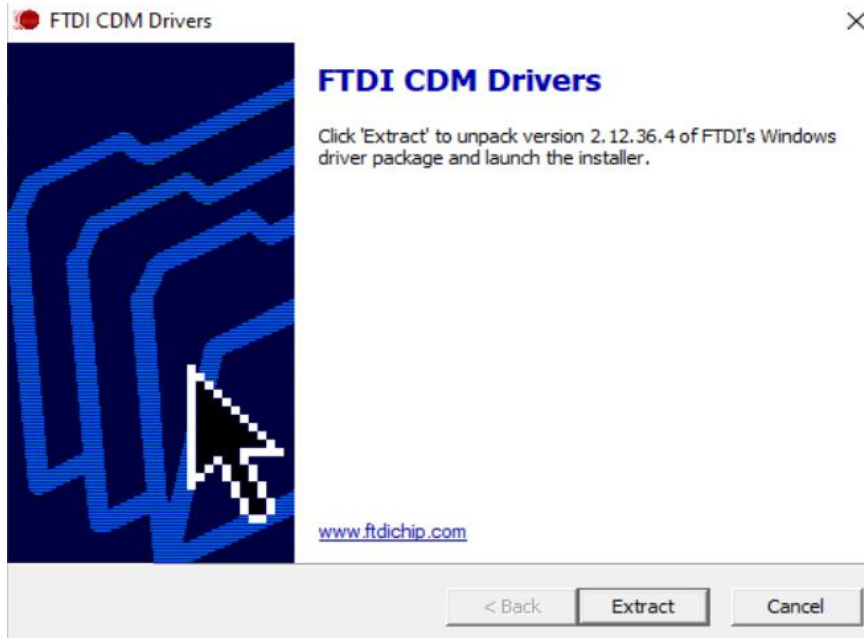

Figure 7-3 Install the serial cable driver

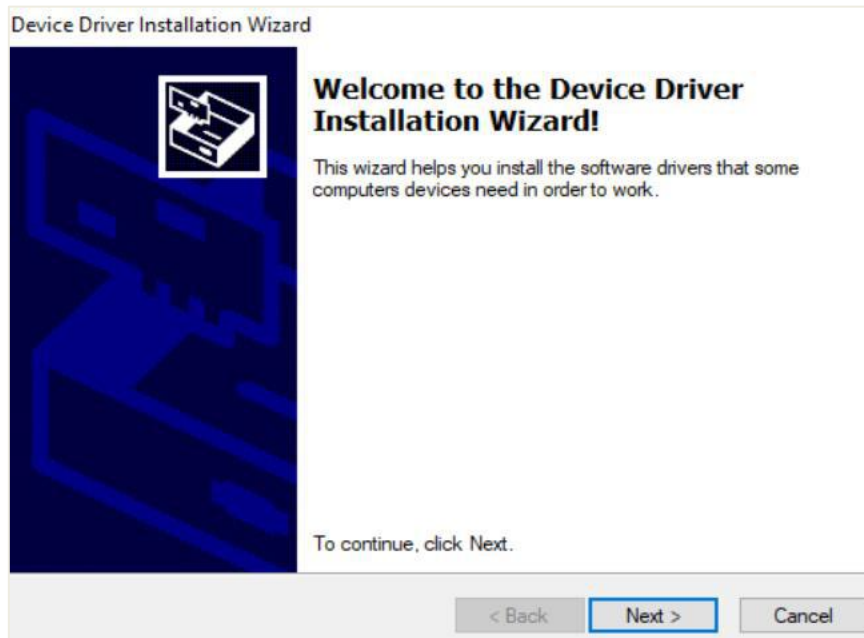

Figure 7-4

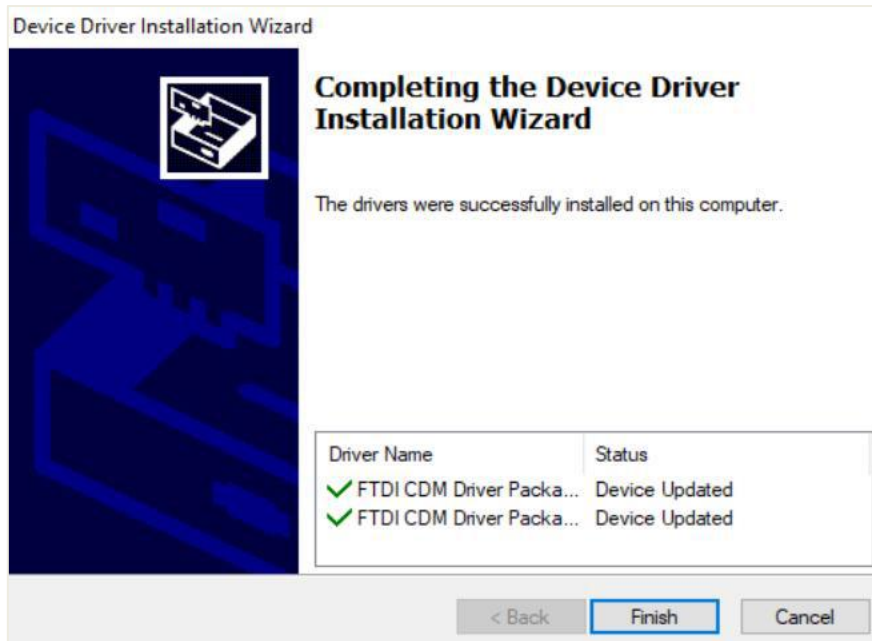

Figure 7-5

- After the serial driver is installed, check the Device Manager, when “



” turns to



”, it indicates that the serial driver is successfully installed.

### 7.3.3 Install the HealthSky Print Template Editor

Double-click the “TemplateEditor-V1.0.4.exe”, and follow the instructions to install the HealthSky Print Template Editor. As shown below. The icon  can be found on the desktop after installation.

Name	Type	Size
 Running Essentials	File folder	
 EMarker-S100-V1.12.00.4.exe	Application	9,801 KB
 TemplateEditor-V1.0.4.exe	Application	5,639 KB

Figure 7-6

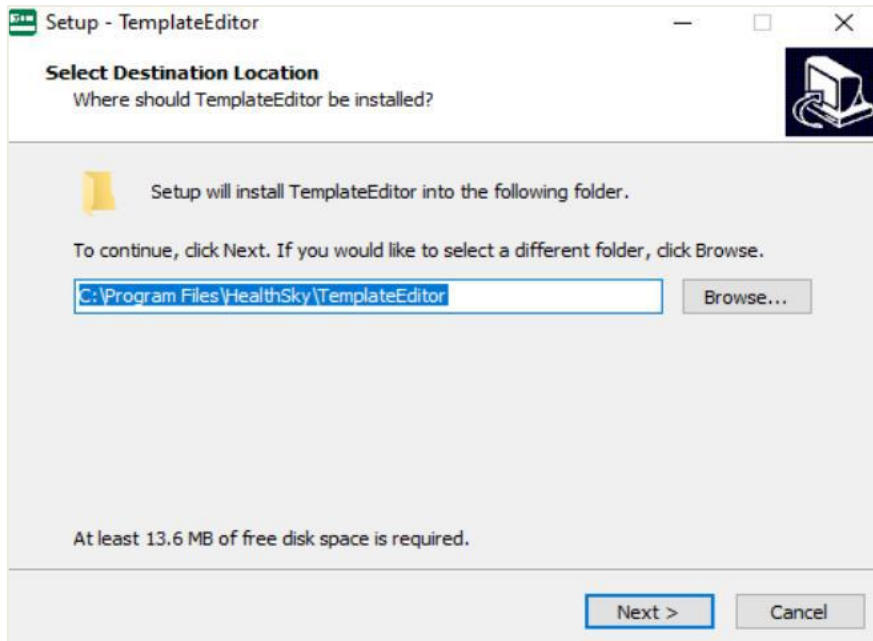

Figure 7-7

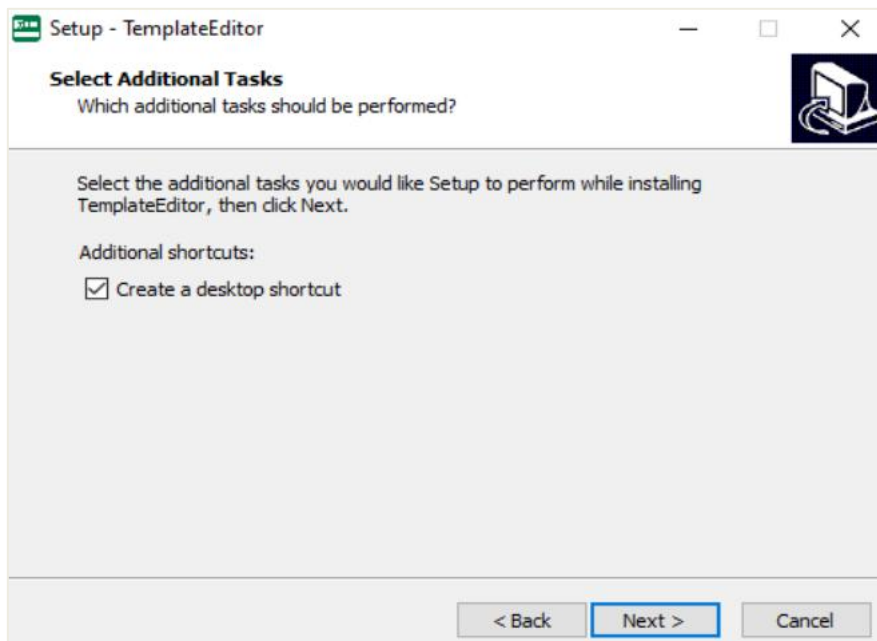

Figure 7-8

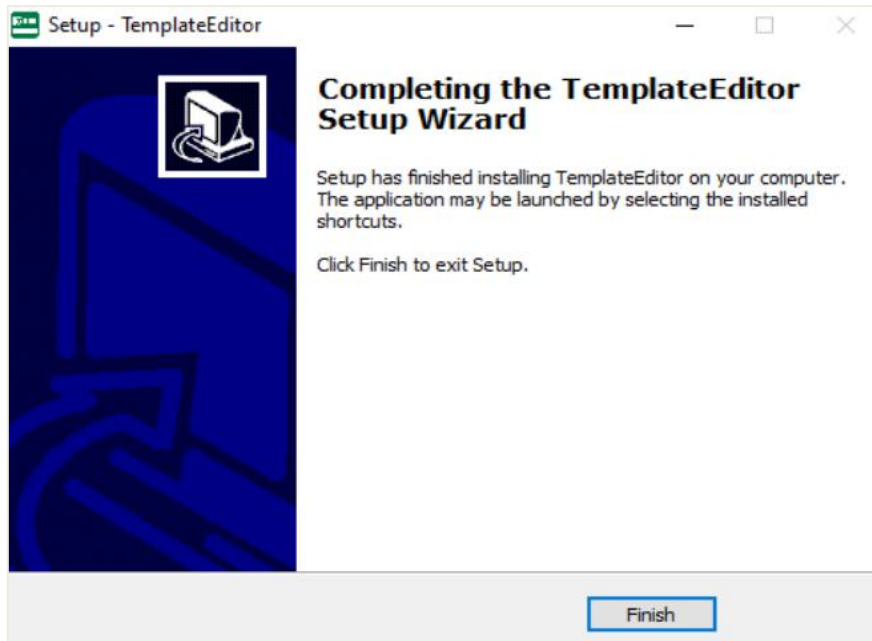



Figure 7-9

### 7.3.4 Install the EMarker-11A-S100 PrintAsst.

1) Install the software

Double-click the “EMarker-11A-S100-V1.12.00.4.exe”, and follow the instructions to install the EMarker-11A-S100 PrintAsst. As shown below. The icon  can be found on the desktop after installation. Administrator authority is required when the software is going to be installed in C Drive.

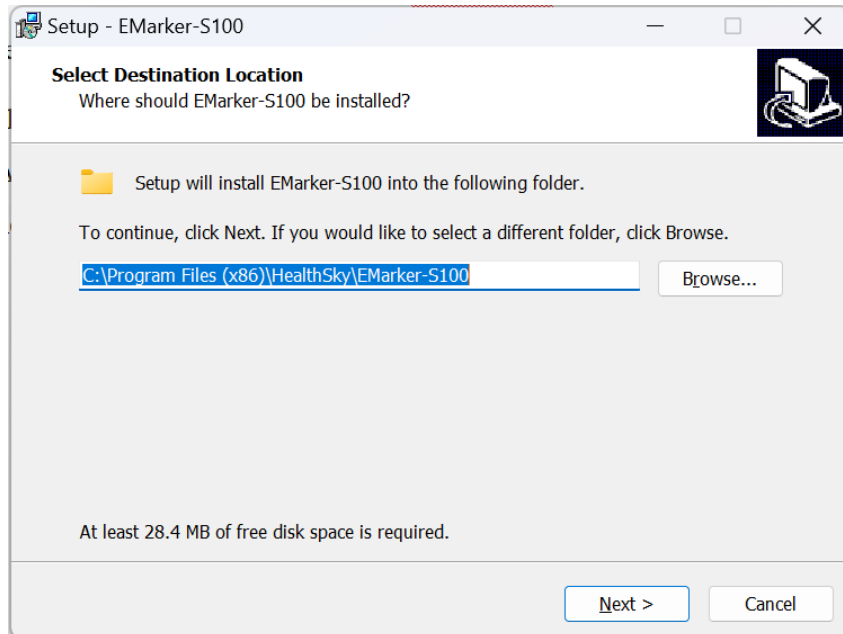

Figure 7-10

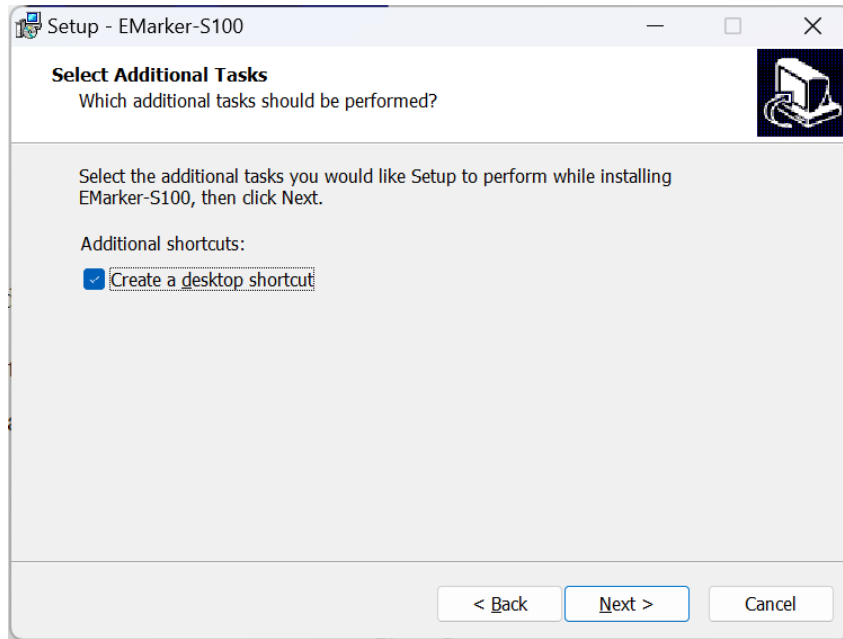

Figure 7-11

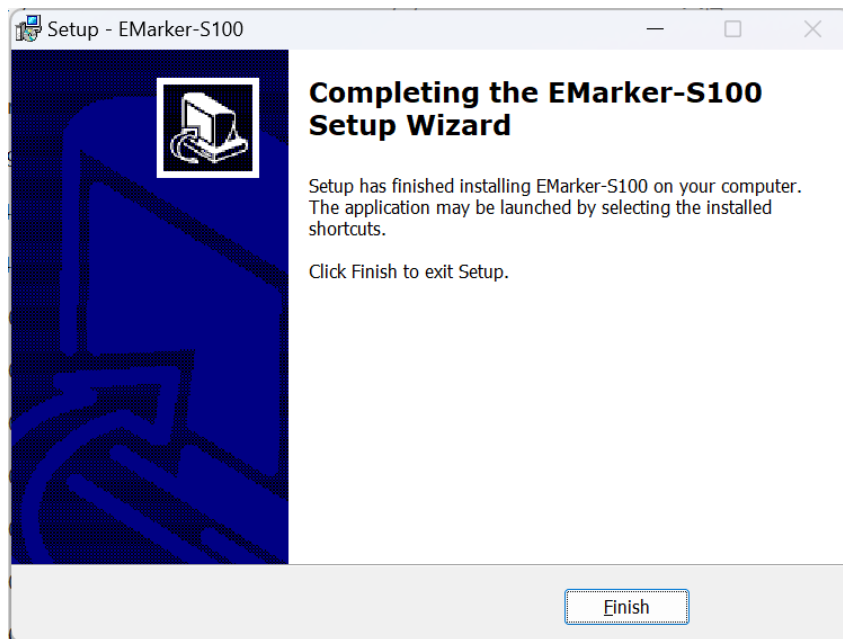

Figure 7-12

2) Run as administrator

Right-click the shortcut icon, select “Properties” in the window that pops up. Click Compatibility, check “Run this program as an administrator” option, and finally click the “OK” button. As shown below.



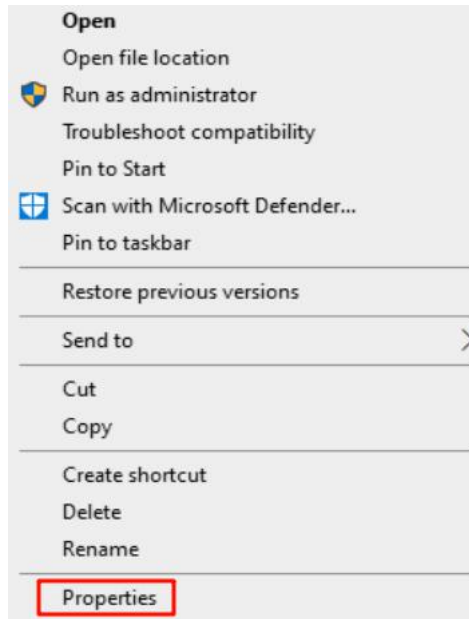

Figure 7-13

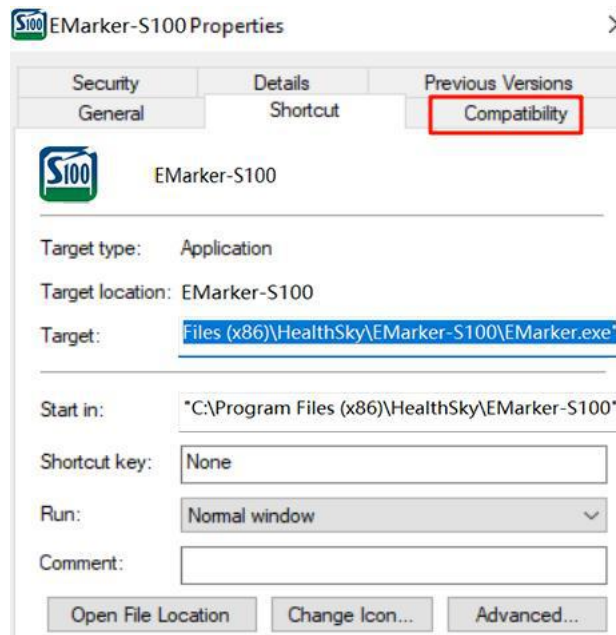

Figure 7-14

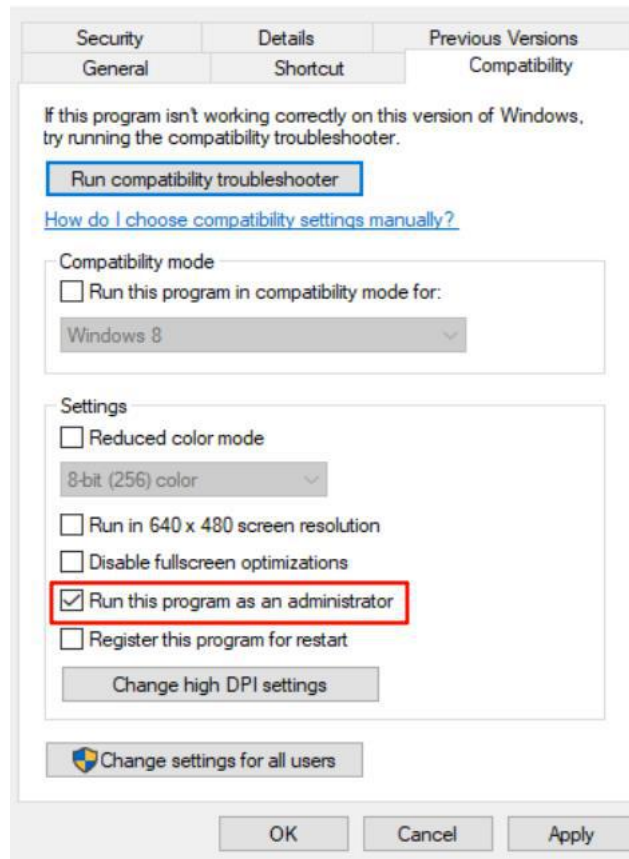

Figure 7-15

## 8. Daily Operation

### 8.1 Fill the Slides

Fill the magazine with slides (Figure 8-1, 8-2) and insert the magazine into the magazine holder (Figure 8-3).

Clip the slide cartridge into place (Figure 8-4).

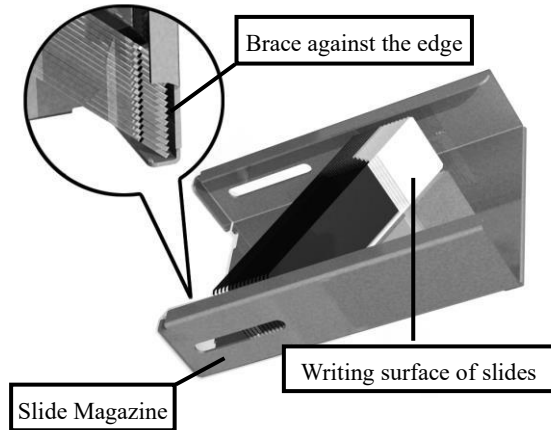

Figure 8-1

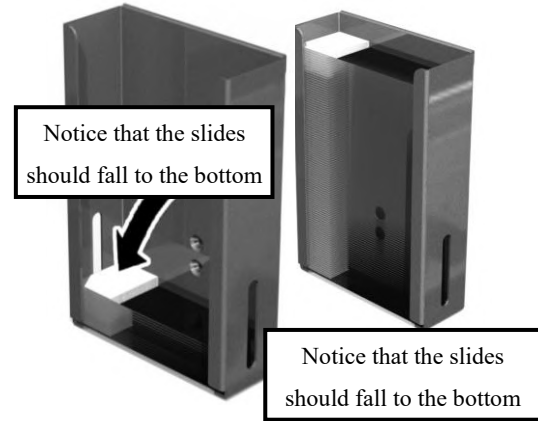

Figure 8-2

1) Fill the slide magazine with slides. Ensure the writing surface is on the left and facing upwards. When filling the magazine, tilt the slides into the two sides of the magazine first. Pay attention that the tail of the slides shall brace against the edge of the magazine and avoid leaking out of the bottom flanging.

2) After the tail of the slides brace against the edge of the magazine, position the slides until as flat as shown in Figure 8-2.

3) It is better to fill about 15 pcs of slides each time, and can be filled in batches up to 100 pcs.

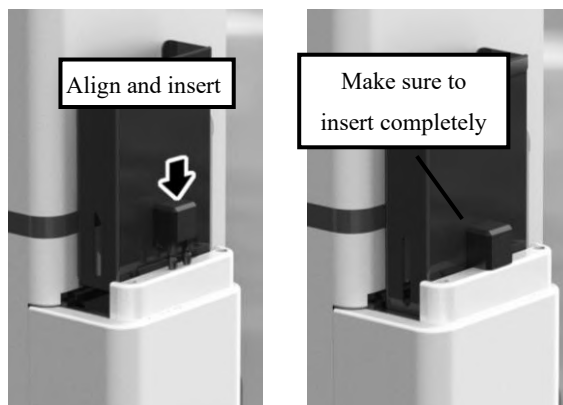

Figure 8-3

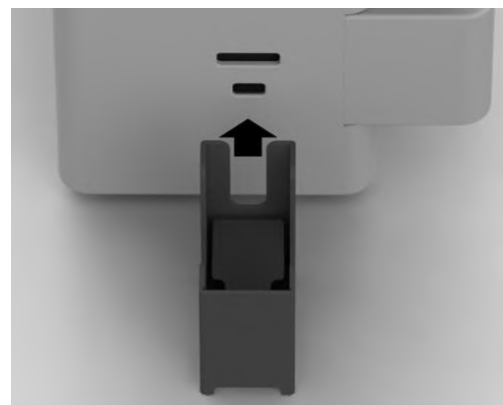

Figure 8-4

4) Hold the magazine and align the rear latch of the magazine with the positioning hole in the position shown in the figure, insert it, and ensure that it is completely inserted.

5) Align the slide cartridge with the slide outlet.

6) Move the slide cartridge towards the slide outlet until the rear of the slide cartridge is close to the shell of the printer. There should be an obvious sense of clamping when the cartridge is in position. When removing, remove in the reverse direction.

## 8.2 Turn on the Printer

Connect the power cable behind the printer, and the data cable between the computer and the printer.

Turn on the power switch at the side of the printer and wait until it is reset.

After the printer is powered on, it takes about 20 seconds to complete the initial preparation.

Please power on the printer first and then open the software.

## 8.3 Print



- Make sure that all printed information on slides is thoroughly verified to avoid any labeling errors.



- Laser is invisible light, do not open the front door panel when the power is on.
- If laser burn occurs, get medical help immediately.

### 8.3.1 Print by EMarker-11A-S100 PrintAsst.

Please refer to **Chapter 10 EMarker-11A-S100 PrintAsst.** for detailed instructions.

### 8.3.2 Print Via LIS

Please refer to **Chapter 11.5 Daily Print** for detailed instructions.

### 8.3.3 Scan to Print

Please refer to **Chapter 12.3 Print** for detailed instructions.



## 9. HealthSky Template Editor

### 9.1 Open the HealthSky Template Editor

Find the *HealthSky Template Editor*  or its shortcut, and double-click to open it.

### 9.2 Switch to the Slide Template

*HealthSky Print Template Editor* can be used to design the slide template and slide template.

Click the “” button to switch to the slide template. Click the “” to the direction of the text. As shown in Figure 9-1.

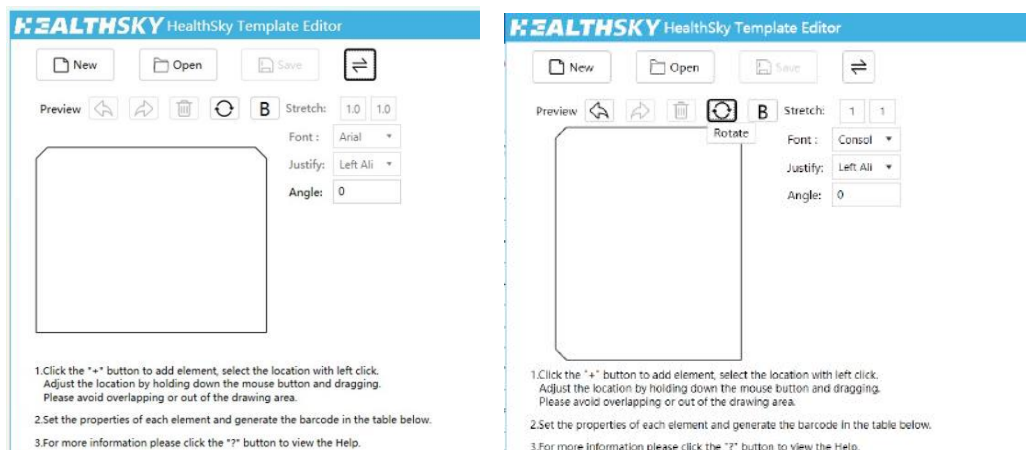

Figure 9-1

## 9.3 Quick Start

The general practice to create the template is to segment printing data, classify the data by fixed text, editable text, serial number, etc. based on the characteristics of the data.

The layout can be designed by changing the properties like the location, font, font size, rotation and mor the location, size, and other characters of the parameters.

### 9.3.1 Fixed Text

The “Fixed Text” can be used as fixed content, such as the year, the laboratory name, or the separator.

The following steps illustrate how to set the year by the “Fixed Text”:

- **Add the element**

Left-click the “” button in front of the “Fixed Text” on the right.

Select a location in the display window, left click to add the element. As shown in Figure 9-2. Move the cursor to the “Fixed Text”, hold down the left mouse button and drag, the location of the “Fixed Text” can be adjusted.

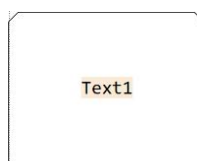

Figure 9-2

- **Name the element**

Double-click the “Name” cell of the newly added element in the table below, change the content to “Prefix”, and then press TAB or click another cell in order to change the name. As shown in Figure 9-3.

It is recommended to enter the name for each added element to avoid confusion and repetition. For example, if there are two hyphens (-), use “hyphen 1” and “hyphen 2” to distinguish them.

- **Input the fixed content**

Double-click the “Custom content” cell and change the content, such as “24-”.

- **Set the other properties**

Set the other properties (Increment, Variation, Leading-0 Blanking) as needed. Refer to **Chapter 4.2 HealthSky Template Editor Interface** for detail information.

No.	Name	Custom Content	Length (Digit)	Increment	Variation	Leading-0 Blanking	Encode
1	Prefix	24-	3	0		<input type="checkbox"/>	<input type="checkbox"/>

Figure 9-3

- **Adjust the font and font size**

Adjust the Font, Justify, and Angle as needed.

Move the cursor to the element in the display window, the current font size will be shown. As shown in Figure 9-4.

Use the mouse wheel to scroll up and down and change the font size.

Ctrl - and Ctrl + on the keyboard could be used to change the font size.

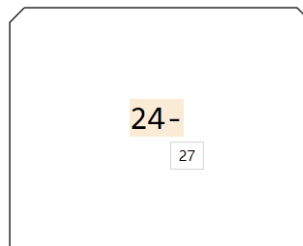

Figure 9-4

### 9.3.2 Serial No.

The “Serial No.” can be used for application scenarios when a series of tasks need to be created, such as the accession no., cassette no., etc. The 1st Serial No. could be used as “Accession No.”, the 2nd Serial No. could be used as “Block No.”, the 3rd serial No. could be used as “Slide No.”.

The following steps illustrate how to set the accession no. by the “Serial No.”:

- **Add the element**

Add the element and adjust the location of the element as the method described in “Fixed Text”.

- **Name the element**

Name the added element as the method described in “Fixed Text”.

- **Set the length**

Specify the digit length according to the number that the user may input. For example, if the largest accession no. is 99999, input 5.

Adjust the location, name the element, and adjust the font size as the method described in “Fixed Text”.

- Set the other properties

Set the other properties (Increment, Variation, Leading-0 Blanking) as needed.

- Adjust the font and font size

Adjust the font and font size as the method described in “Fixed Text”.

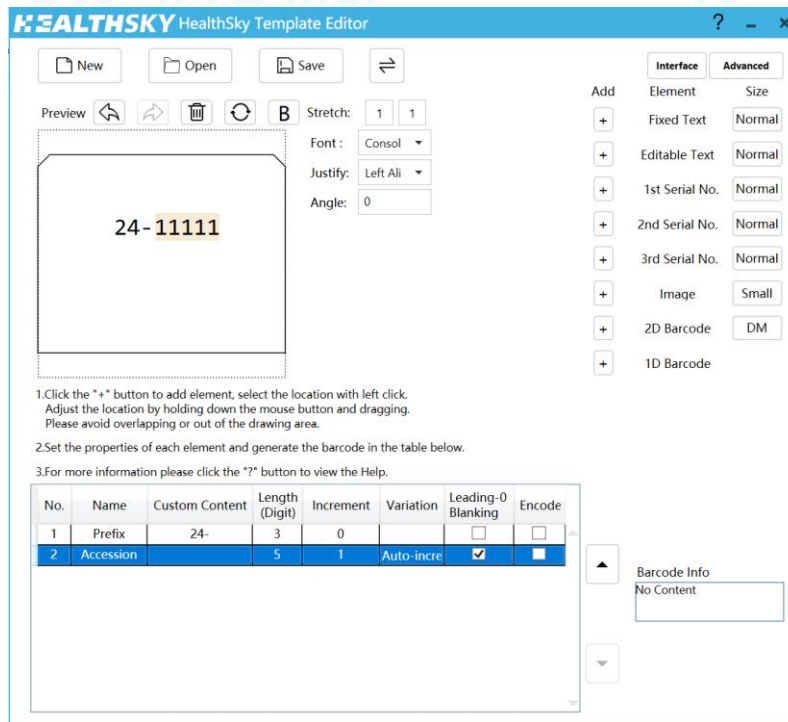

Figure 9-5

Three types are available for “Serial No.”: pure numbers, pure letters, and alphanumerics. Input letters, numbers, or alphanumerics in the “Custom Content” of the “Serial No.” to set the property. The default “Serial No.” is pure numbers.

### Pure Letters Type

The Serial No. only contains letters, such as “aa”, “aB”, “AA”, and etc.

In this type, the Serial No. increases follow the alphabetical order. For example, when the increment is 2, the next of ACZ is CEB.

### Pure Numbers Type

The Serial No. only contains numbers.

In this type, the numbers increase based on the decimal system. For example, when the increment is 2, the next of 100 is 102.

### Alphanumerics Type

The Serial No. combines both alphabetic characters (letters) and numeric characters (numbers), such as “1a”, “A1”, and etc.

In this type, the Serial No. increases from 0 to Z (0,1,2,3...7,8,9, A, B, C...X, Y, Z.). For example, the next of 19 is 1A, the next of 1Z is 20. That is, 9 plus 1 becomes A, Z plus 1 becomes 0 and carry 1.

### 9.3.3 Editable Text

The “Editable Text” can be used for application scenarios when the printing content requires to be edited on-site, such as

the date, the specimen no. the block no., the stain type etc.

Add the element, adjust the location, and set the properties as the method described in the “Fixed Text” and “Serial No.”.

Frequently used words can be input in the “Custom Content”. The words will be listed in the *EMarker-11A-S100 PrintAsst.* accordingly. Use separators such as “,” “;”, or blank to separate the words.

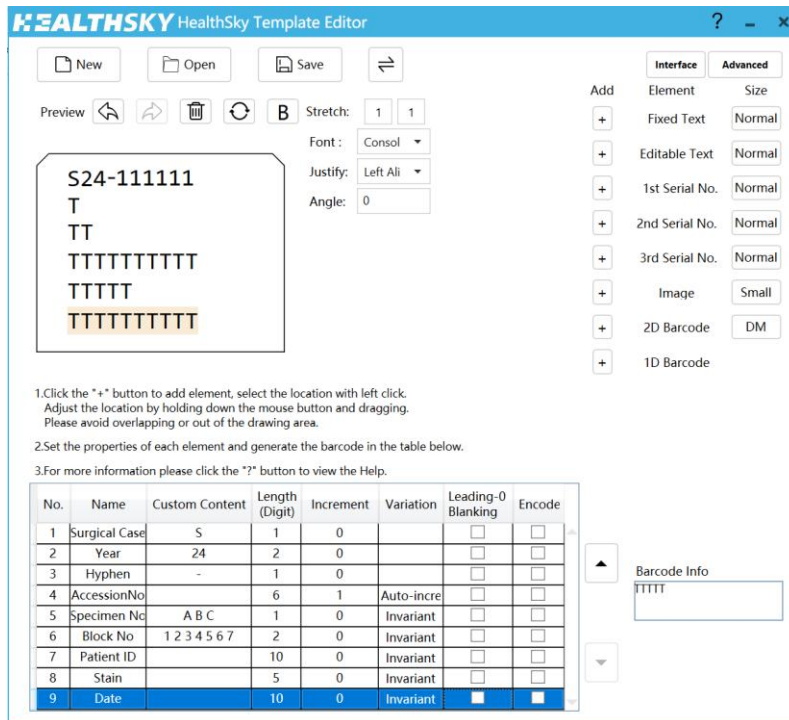

Figure 9-6

### 9.3.4 Barcode Generation

Both one-dimension barcode and two-dimension barcode can be generated.

Code128A is available for one-dimension barcode.

QR code and DataMatrix are available for two-dimension barcode.

Add the barcode element, adjust the location and set the properties as the method described above.

Double-click the selection box of the “Encode” column, the corresponding element will be used to generate barcode.

“Fixed Text”, “Editable Text”, and “Serial No.” are supported for barcodes generation.

The encoded content could be previewed in the window on the right. The order of the encoded content can be adjusted by clicking the up and down arrows on the right.

The encoding order is adjustable by adjusting the order of the encoding content. Adjust the order by the “▲” and “▼” buttons on the right side of the table.



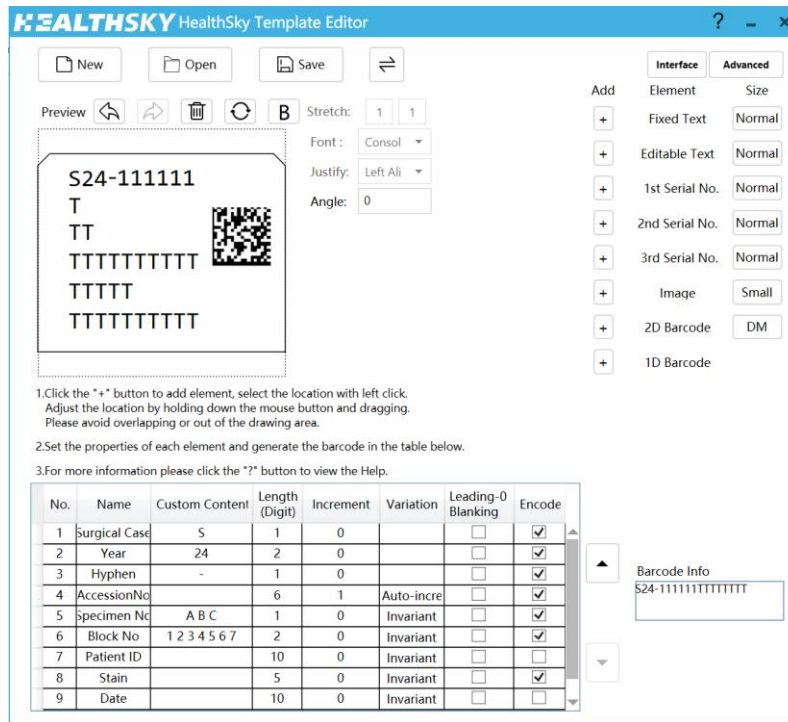



Figure 9-7

### 9.3.5 Save the Template

Save the template and name it properly.

Click the “  Save ” button, select a path in the pop-up window, enter the template name, and click “Save” to save the template to the specified path.

### 9.4 Shortcut Keys

- 1) Use the shortcut key F1 to enter the help page.
- 2) Arrow keys on the keyboard (up, down, left and right): move the selected elements.
- 3) Ctrl + Z/ Ctrl + Y: undo and redo.
- 4) Ctrl + S/ Ctrl + O: save/open the template.
- 5) Ctrl + ↑ / Ctrl + ↓ : Align the selected elements to the top or bottom.
- 6) Ctrl + ← / Ctrl + → : Align the selected elements to the left or right.
- 7) Ctrl + H/ Ctrl + J: Align the selected elements to the horizontal center or vertical center.
- 8) Ctrl + + / Ctrl + - : Resize the regular sized elements by pressing the Ctrl + + and Ctrl + - shortcuts or by directly by the mouse wheel.

## 10. EMarker-11A-S100 Print Asst.

### 10.1 Open the EMarker-11A-S100 PrintAsst.

Find the *EMarker-11A-S100 PrintAsst.* or its shortcut, and double-click to open it. Make sure to “Run as an administrator”. Refer to **Chapter 7.3.4 Install the EMarker-11A-S100 PrintAsst.**

### 10.2 Quick Start

#### 10.2.1 Select the Template

Click the “ ”, the file selection window will pop up. Select the template created previously and open it. The preview of the current template will be displayed at the top of the interface. As shown in Figure 10-1.

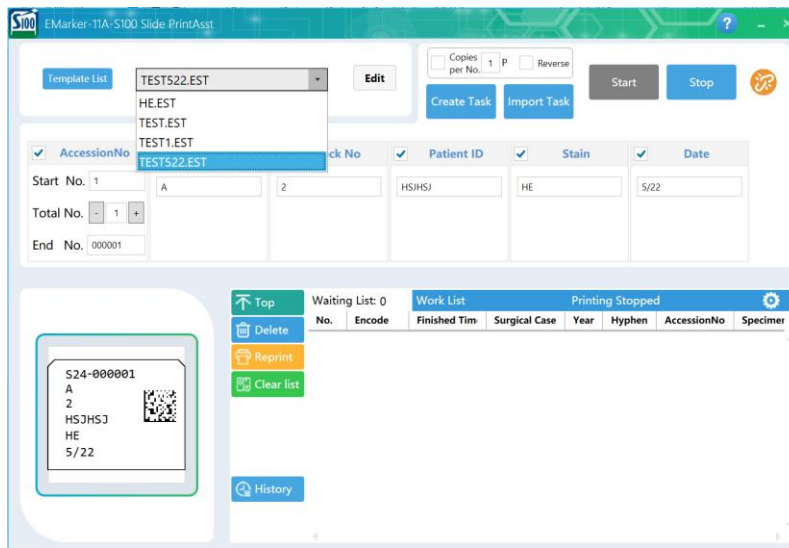

Figure 10-1

#### 10.2.2 Input Printing Data

Input the printing data as shown below.

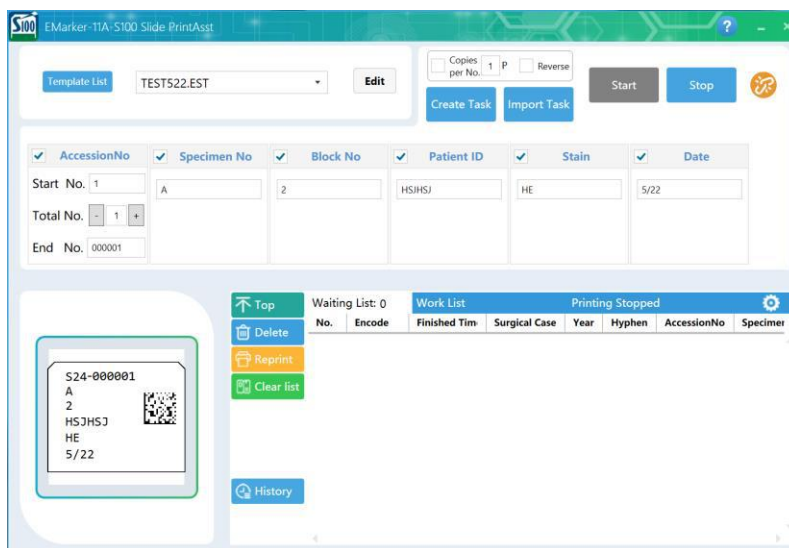



Figure 10-2

### 10.2.3 Enter the Printing Mode

Click the “  ” button to enter the printing mode.

### 10.2.4 Create Printing Task

Click the “  ” button, slides will be printed consecutively. The details of the generated tasks can be reviewed in the “Work List” below. As shown in Figure 10-3. Only under the printing mode, the tasks in the waiting list will be printed.

Waiting List: 7		Work List		Printing Stopped				
No.	Encode	Finished Tim	Surgical Case	Year	Hyphen	AccessionNo	Specimer	
1	S24-000001A	Unfinished	S	24	-	000001	A	
2	S24-000002A	Unfinished	S	24	-	000002	A	
3	S24-000003A	Unfinished	S	24	-	000003	A	
4	S24-000004A	Unfinished	S	24	-	000004	A	
5	S24-000005A	Unfinished	S	24	-	000005	A	
6	S24-000006A	Unfinished	S	24	-	000006	A	
7	S24-000007A	Unfinished	S	24	-	000007	A	

Figure 10-3

## 11.LIS Interface

### 11.1 Preparations

The EMarker-11A-S100 can interface with the Laboratory Information System (LIS) or other information management systems in order to eliminate the need for manual data entry, reduce the risk of errors, and streamline workflows.

The HealthSky printer software is designed to interface with LIS via files. Contact the relevant personnel of the Laboratory Information System before implementing the interface.

### 11.2 File-based Interface

The data is transferred in the form of a file. A “.txt” file or a “.xls” file containing the printing data will be generated by the LIS and saved to a certain path. The “.txt” file needs to be encoded in UTF-8. There can be multiple printing tasks in a file, one task shall be in one line. The generated file is then identified and processed by the *EMarker-11A-S100 PrintAsst.*

### 11.3 Interface

#### 11.3.1 Parse the to-be printed content

The printing content generated by LIS generally includes “Year”, “Accession No.”, “Specimen No.”, “Block No.” and other fields, which may be segmented by “\$”, “,” or other separators. Parse the content generated by clarifying the separator and the meaning of each field. Each field to be interfaced with is regarded as an “Editable Text”.

Take Figure 11-1 as an example. The left content is the data generated by the LIS. On the right is the required printing on the slide. “24” stands for the year, “123456” stands for the accession no., “A” stands for the specimen no., “01” stands for the block no., “HE” stands for the stain. The separator is the “,”.

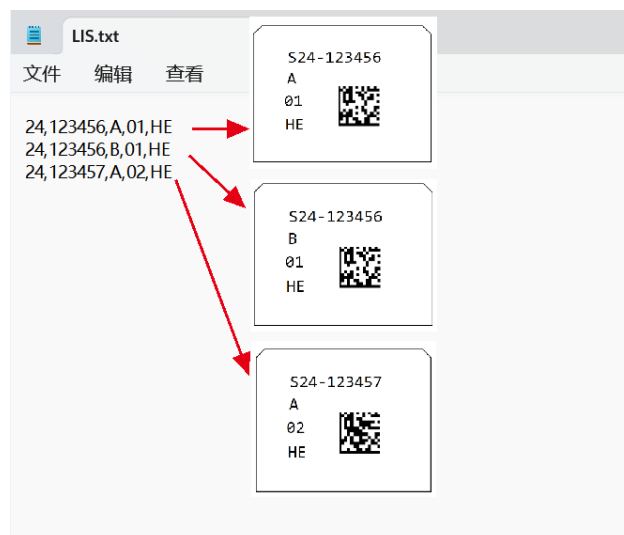

Figure 11-1

#### 11.3.2 Create Template

##### • Add Editable Text

Each field to be interfaced with is regarded as an “Editable Text”. Add one or more “Editable text” based on the number of fields to be interfaced with. Set the length of each “Editable Text” to the maximum length of the field to be interfaced with. Add a “\*” before the name of the added “Editable Text” to be interfaced with. As shown in Figure 11-2.

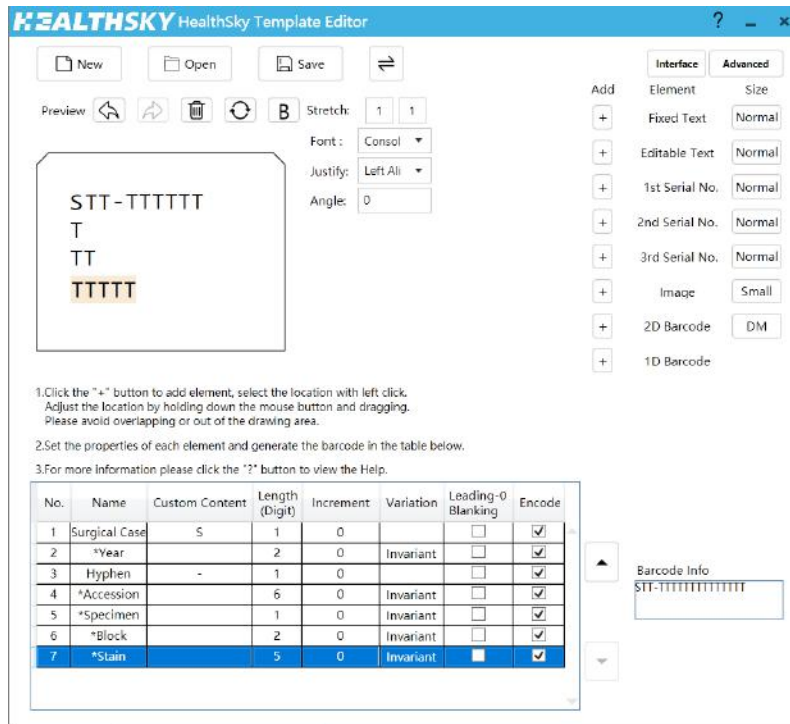

Figure 11-2

• Add Other Elements

Add other elements (such as fixed text, separator or barcode as needed. As shown in Figure 11-3.



Figure 11-3

• Interface

Click the “Interface” button, check the “Separator” dialogue box, and enter the separator of the printing contents generated by the LIS. The separator is “,” in this case.

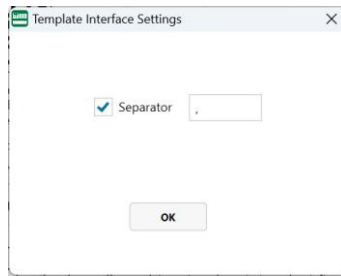

Figure 11-4

- **Save the Template**

Save the template to a certain path.

## 11.4 Print Test

Open the *EMarker-11A-S100 PrintAsst*, select the template created and open it.

Press the key combination “Ctrl+H+S” to open the advanced Settings.

Select the directory where the interface files are saved. If the interface file type is an excel file and there are multiple sheets in the file, the sheet name needs to be specified here. As shown in Figure 11-5.

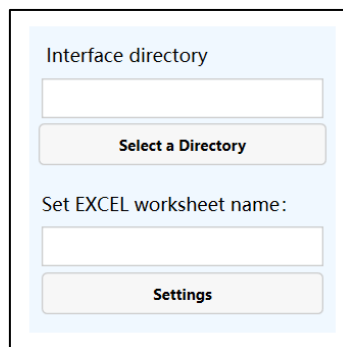

Figure 11-5

Create a new .txt document on the computer desktop, change the content to “24, 123456, A, 01, HE”, save the file and copy it to the interface directory just set, a print task will be automatically generated.

## 11.5 Daily Print

Open the *EMarker-11A-S100 PrintAsst*, select the interface template, click the “Start” button to enter the printing mode, then minimize the window.

Select several tasks and click the “Print” button on the LIS, wait a few seconds, the printer will print out the selected tasks.

## 12. Scan to Print

The EMarker-11A-S100 supports scan to print. Use a barcode scanner to scan the barcode on the cassette for convenient and quick printing, and improving work efficiency.

The *EMarker-11A-S100 PrintAsst.* is designed to connect with a USB Barcode Scanner directly. Every time a barcode is scanned by the scanner, one printing task will be generated by the software automatically.

“Serial No.” can be optionally set when a series of printing tasks need to be created.

### 12.1 Preparations

#### 12.1.1 Use a USB Barcode Reader

Connect the USB Barcode Reader to the computer.

#### 12.1.2 Test

Open a text document on the computer, scan some barcodes with the scanner. Make sure that each content scanned takes up a separate line. As shown in Figure 12-1. If the contents scanned are all listed together, the user need to set the output suffix of the scanner.

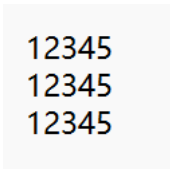

```
12345
12345
12345
```

Figure 12-1

### 12.2 Create Template

Parse the to-be printed content and create a template.

Take Figure 12-2 as an example. The left is the content scanned. The right is the required printing on the slide.

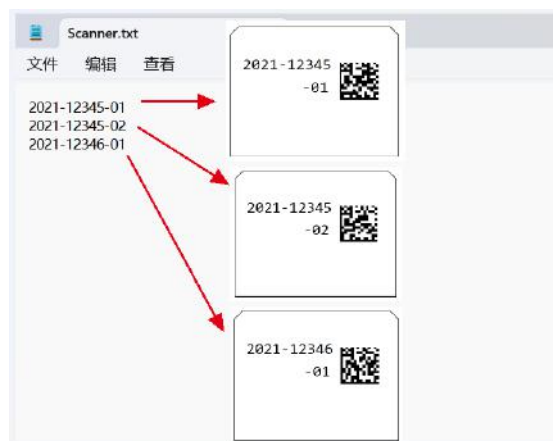

Figure 12-2

#### ● Add Editable Text

Each field to be printed is regarded as an “Editable Text”. Add one or more “Editable text” based on the number of fields to be printed. Set the length of each “Editable Text” to the length of the field. Space, separator, etc. are also counted. Add a “\*” before the name of the added “Editable Text”.

In this case, there are two fields, field 1(2021-12345) counts as 10 digits and field 2(-01) counts as 3 digits. Add “Editable Text” accordingly. As shown in Figure 12-3.

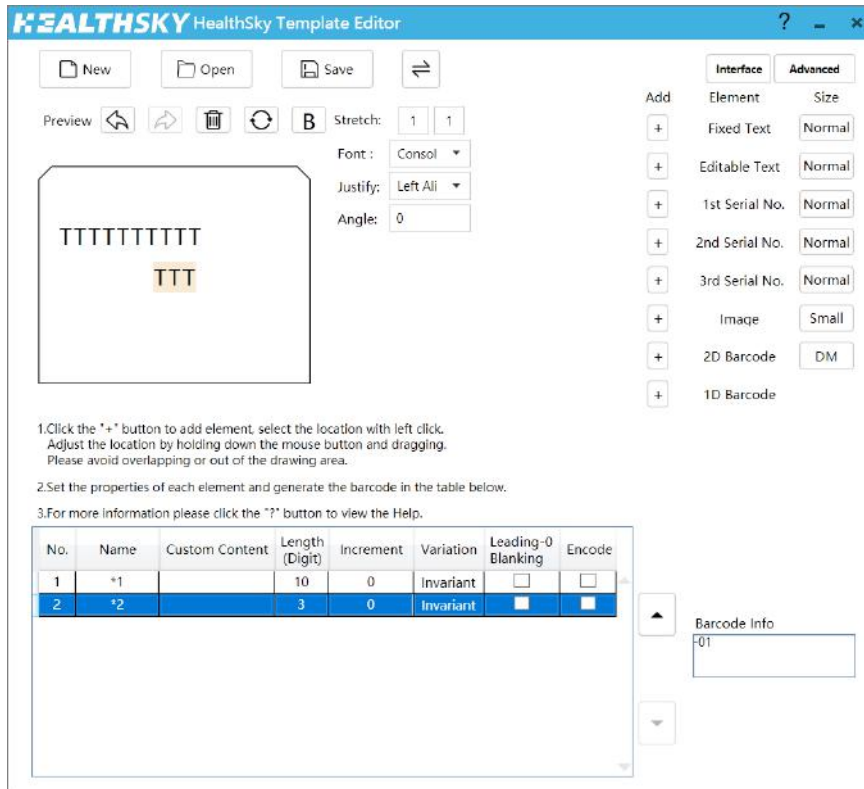

Figure 12-3

• Add Barcode

Add barcode as needed. As shown in Figure 12-4.

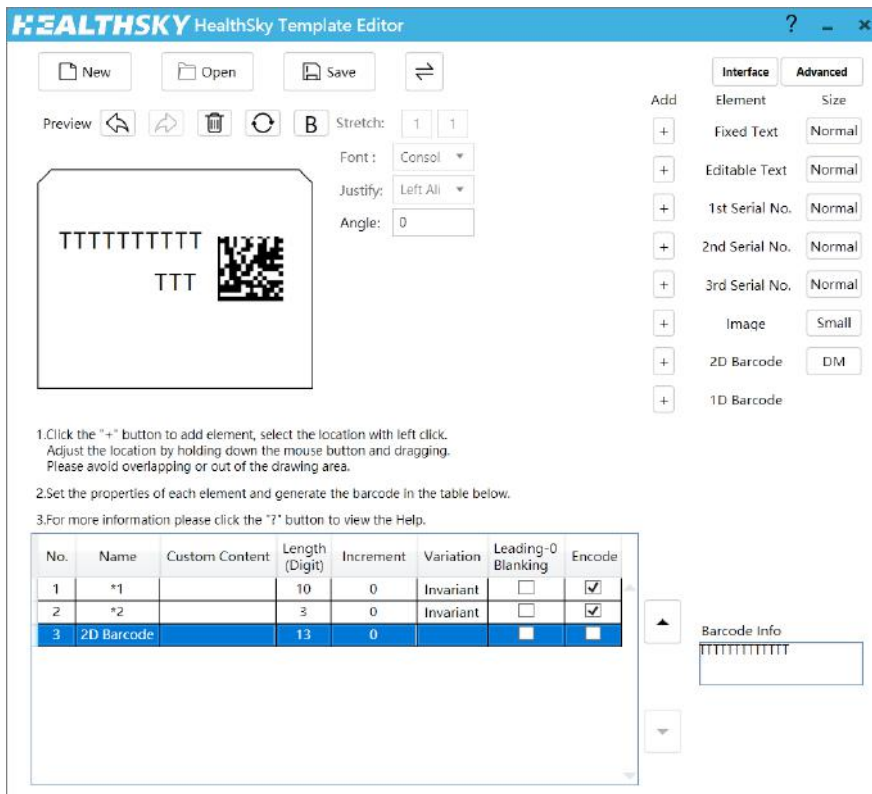

Figure 12-4



• **Add Serial No.**

Serial no. can be used when multiple slides from the same cassette need to be printed.

Add the element, set the length, set the “Variation” to “Auto-increment”. As shown in Figure 12-5.

After the setting, when continuously scanning the same barcode of the cassette, the serial no. will automatically increase.

When scanning different barcode, the serial no. starts over.

No.	Name	Custom Content	Length (Digit)	Increment	Variation	Leading-0 Blanking	Encode
1	*1		5	0	Invariant	<input type="checkbox"/>	<input checked="" type="checkbox"/>
2	*2		5	0	Invariant	<input type="checkbox"/>	<input checked="" type="checkbox"/>
3	*3		3	0	Invariant	<input type="checkbox"/>	<input checked="" type="checkbox"/>
4	Serial No.1		4	1	Auto-	<input type="checkbox"/>	<input checked="" type="checkbox"/>
5	2D Barcode		17	0	Invariant	<input type="checkbox"/>	<input type="checkbox"/>

Invariant  
Auto-increment  
 Back to 1

Figure 12-5

• **Interface**

Click the “Interface” button, check the “Separator” dialogue box, and enter the separator. The separator is “-” in this case.

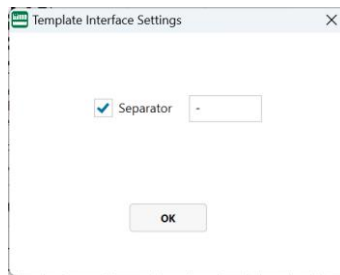

Figure 12-6

• **Save the Template**

Save the template to a certain path.

### 12.3 Print

Open the *EMarker-11A-S100 PrintAsst*, select the template created and open it.

Click the “Start” button to enter the printing mode. Click the “Edit” button to convert it to the “Scan” button to enter the “Scan to print” mode.

Scan the barcode, the slide will be printed out.

## 13. Trouble Shooting



- When slide jam occurs, rectify the fault in time. Forcibly running the device may cause serious damage to the device.
- For inspection of lines or components by opening the enclosure, please contact after-sales service.

No.	Error Symptom	Possible Cause	Remedy
E1.1	The printer fails to reset when switched on.	No electricity or the switching circuit is faulty if the indicator light is not on.	Check whether the socket is powered on. Check whether the power cable is securely plugged in. Check whether the fuse has blown. If the printer still cannot be turned on, please contact the after-sales service.
E1.2		Internal fault of the printer if the indicator light is on.	Please contact the after-sales service.
E2.1	Abnormal noise occurs during reset.	Slide stuck at the slide magazine.	Remove the front door panel, push the slide back through the access using tweezers, pull out the slide magazine and remove the stuck slide.
E2.2		The slider for pushing in or out the slide is obstructed by a foreign object, or the path for pushing out the slide is blocked by a foreign object.	Check if there are any foreign objects stuck at the slide inlet. Inspect the slide outlet for any foreign objects. If found, use tweezers or other tools to remove them and then restart the device. If no foreign objects are found, please contact the after-sales service.
E3.1	Fail to connect.	The control software is not compatible with the device.	Ensure that the device model matches the software that is being opened.
E3.2		The connection cable driver is not installed or the connection cable is faulty	Reconnect the data cable securely. If the connection still fails, check the Device Manager on your computer system. If there is an exclamation mark icon next to the COM port related to the serial cable, it may indicate that the driver is not installed correctly and needs to be reinstalled. If no information appears for the COM port, the data cable might be damaged and should be replaced.
E3.3		The software is not running under Administrator status.	Close the software and re-open it after "Run as administrator" is checked, wait for 10 seconds and re-try. Please contact the after-sales service if the problem is still not solved.

E4	The software reports that the front motor or the rear motor is faulty and abnormal noise occurs during the printing process.	The slider for pushing in or out the slide is obstructed by a foreign object, or the path for pushing out the slide is blocked by a foreign object.	Check if there are any foreign objects stuck at the slide inlet. Inspect the slide outlet for any foreign objects. If found, use tweezers or other tools to remove them and then restart the device. If no foreign objects are found, please contact the after-sales service.
E5.1	The software reported that there was no slide, but the actual slide was pushed in and out, the print area was blank.	Use a white paper to check whether the detection sensor of the print position is working normally. If the paper can be identified when it close to the sensor.	Wipe the sensor surface clean and try again. When the wiping is ineffective, it may be that the identification rate of the slide is low. Replace the slide with a type of slide approved by the manufacturer.
E5.2		Use a white paper to check whether the detection sensor of the print position is working normally. If the paper cannot be identified when it close to the sensor.	Wipe the sensor surface clean and try again. When the wiping is ineffective, power off the device, open the front door panel, check the cable connections to the sensor, and replace the sensor if necessary.
E6.1	The software reports the slide cartridge is full, but it is not.	There is strong light that is directly directed to detector.	Avoid direct light.
E6.2		Detector rear line fault.	Please contact the after-sales service.
E7.1	The slide cartridge is full, the software does not prompt, and continues to print.	Use a white paper to check whether the detection sensor of the print position is working normally. If the paper can be identified when it close to the sensor.	Wipe the sensor surface clean and try again. When the wiping is ineffective, it may be that the slide magazine is positioned improperly, re-insert the magazine and try again.
E7.2		Use a white paper to check whether the detection sensor of the print position is working normally. If the paper cannot be identified when it close to the sensor.	Please contact the after-sales service.
E8.1	The print is mostly unclear or blank.	Unapplicable slide.	Use the applicable slide. Please contact the after-sales service if the problem is still not solved.
E8.2		Slide undetected.	Wipe the sensor surface clean and try again.
E8.3		If the unclear position is the same in each printed area, it may be a galvanometer or field mirror fault.	Turn off the power of the device, open the front door panel, borrow the light, and observe whether there is an area inside the field mirror that becomes opaque, and whether the mirror of the galvanometer is uniform in color. If nothing abnormal, check the connection line of the

			galvanometer and replace the galvanometer or field mirror if necessary.
E8.4		If the unclear position is different in each printed area, it may be a laser fault or a software fault.	Check the connection cables of the laser and the laser power supply module, and replace the laser if necessary.
E8.5		The color of the print is generally light, or blank	Replace the laser if necessary.
E9.1	The interface printing or scan to print contains no content or incorrect content	No recognize feedback signal, such as sound or flicker, from the scanner.	Check the connection line of the scanner or replace the scanner, use the barcode in the template of the screen, and confirm that the scanner can send the feedback signal correctly when scanning the code.
E9.2		There is recognize feedback signal from the scanner, the task is not generated in the work list, no slide is pushed in.	Possibly the template is incorrect. Verify that the used template is the one for interface. Verify that the encoding content, fields, and separator are correct.
E9.3		There are tasks in the work list, there are slides pushed in.	Refer to E8.1 to E8.5 for trouble shooting.
E9.4		The printed slide is the previous print task. There's probably internal slide retention.	When the device stops working, open the front panel, check and remove the stranded slide.

## 14. Maintenance

### 14.1 Device Clean

#### 14.1.1 Surface Clean

- 1) Turn off the power of the device and remove the consumables and consumable carrying parts.
- 2) Wet a soft cloth with clean water and wring it out until no water droplets fall naturally, use the cloth to clean the external plastic and metal parts of the device. Avoid water into the device.
- 3) Do not use organic solvents to wipe the plastic parts, as it may cause damage to the plastic surface.

#### 14.1.2 Internal Clean

- 1) Remove the front door panel, use a soft brush to brush the inside of the printer to remove dust.

## 14.2 Changing Fuses



- Do not apply excessive force to the fuse, otherwise it may cause the fuse to break and cause injury.

To replace the fuses:



Switch off the power, unplug the power cord at the back of device, and use a slotted screwdriver to pry out the fuse holder on the power cord socket.



Bend the old fuse to both sides and take it out, snap the new fuse in from both sides, and put it back into the slot to complete the replacement.

## 14.3 Changing Filter

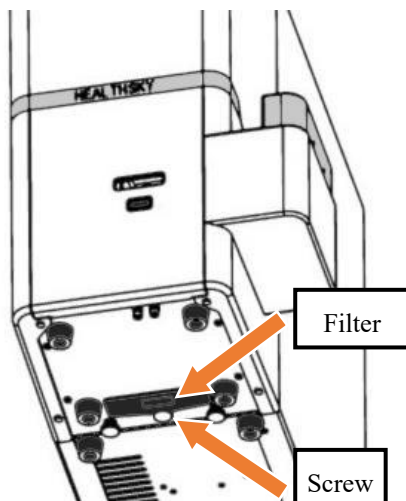

- 1) Turn off the power and lift the front part of the device. Disconnect the power and data cables at the back of the device before fully lift and stabilize the front panel.
- 2) Unscrew the indicated screws and remove the old filter from the device.
- 3) Insert the new filter vertically into position, ensuring it is fully inserted. Align the screw holes and make sure the filter's external sealing plate is flush with the bottom of the device.
- 4) Tighten the screws back in place.

Product Name: Laser Slide Printer

Model: EMarker-11A-S100

Manufacture date and service life: please see the nameplate.

---



**Hangzhou HealthSky Biotechnology Co., Ltd.**

Room 302, Building No 1, Room 201, Building No 1-1, No.2073, Jinchang Road, Liangzhu Street,  
Yuhang District, 311100 Hangzhou City, Zhejiang Province, PEOPLE'S REPUBLIC OF CHINA

Tel: +86 572 5020998

Fax: +86 572 5020991

e-mail: [overseas@healthskybio.com](mailto:overseas@healthskybio.com)

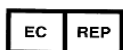

**SUNGO Europe B.V.**

Fascinatio Boulevard 522, Unit 1.7, 2909VA Capelle aan den IJssel, The Netherlands

文件编号：

文件名称：EMarker-11A-S100 User's Manual

版本号：A

编写：张马莉

审核：

批准：

生效日期：

2024-07-22

A版变更内容如下：

- 1) P4页 EMC 相关：根据实际外检标准与实际报告更新该章节
- 2) 1.1 章节：安全标识中增加激光辐射警告，电源开关符号说明，激光灼伤警告
- 3) 1.2 章节：安全预防措施使用栏中增加“确保玻片上的所有打印信息都经过彻底核实，以避免任何标签错误”的警示。
- 4) 3 参数章节：设备尺寸更改为 220×420×380 (mm)
- 5) 4.1.2 章节：增加前门面板的图示及说明；增加铭牌的图示及说明；增加“电源接口配有保险丝安装盒”的说明；增加电源线图示及说明。
- 6) 6.1.3 章节：更新工作台尺寸要求
- 7) 6.4 章节：设备安装章节 文字提示改成黄色警告标提示
- 8) 6.5 章节：增加设备储存与运输说明
- 9) 8.3 章节：增加“确保玻片上的所有打印信息都经过彻底核实，以避免任何标签错误”的警示；增加激光安全相关提示
- 10) 13 章节：增加“出现卡玻片时，应及时排除故障。强行运行设备可能会导致设备严重损坏”警示；增加“打开外壳检查线路或部件，请联系售后服务”警示；根据中文版补充故障排除内容
- 11) 14.2 章节：增加保险丝更换相关内容
- 12) 14.3 章节：增加过滤器更换相关内容